



TPC121/150/170

Touch Panel PC
User's Manual

Copyright

This publication contains information that is protected by copyright. No part of it may be reproduced in any form or by any means or used to make any transformation/adaptation without the prior written permission from the copyright holders.

This publication is provided for informational purposes only. The manufacturer makes no representations or warranties with respect to the contents or use of this manual and specifically disclaims any express or implied warranties of merchantability or fitness for any particular purpose. The user will assume the entire risk of the use or the results of the use of this document. Further, the manufacturer reserves the right to revise this publication and make changes to its contents at any time, without obligation to notify any person or entity of such revisions or changes.

© 2014. All Rights Reserved.

Trademarks

Product names or trademarks appearing in this manual are for identification purpose only and are the properties of the respective owners.

FCC and DOC Statement on Class A

This equipment has been tested and found to comply with the limits for a Class A digital device, pursuant to Part 15 of the FCC rules. These limits are designed to provide reasonable protection against harmful interference when the equipment is operated in a residential installation. This equipment generates, uses and can radiate radio frequency energy and, if not installed and used in accordance with the instruction manual, may cause harmful interference to radio communications. However, there is no guarantee that interference will not occur in a particular installation. If this equipment does cause harmful interference to radio or television reception, which can be determined by turning the equipment off and on, the user is encouraged to try to correct the interference by one or more of the following measures:

- Reorient or relocate the receiving antenna.
- Increase the separation between the equipment and the receiver.
- Connect the equipment into an outlet on a circuit different from that to which the receiver is connected.
- Consult the dealer or an experienced radio TV technician for help.

Notice:

1. The changes or modifications not expressly approved by the party responsible for compliance could void the user's authority to operate the equipment.
2. Shielded interface cables must be used in order to comply with the emission limits.

Table of Contents

Copyright.....	2
Trademarks.....	2
FCC and DOC Statement on Class A.....	2
About this Manual.....	4
Warranty.....	4
Static Electricity Precautions.....	4
Safety Measures.....	4
About the Package.....	5
Chapter 1 - Introduction.....	6
Overview.....	6
Key Features.....	7
Specifications.....	8
Getting the Know the TPC121/150/170.....	11
Mechanical Dimensions.....	12
Chapter 2 - Getting Started.....	14
Preparing the System.....	14
Installing Devices.....	14
Configuring the BIOS.....	14
Installing the Operating System.....	14
Installing the Drivers.....	14
Chapter 3 - Installing Devices.....	15
Removing the Chassis Cover.....	15
Installing an SODIMM.....	16
Installing a SATA Drive.....	17
Installing a Mini PCIe Card.....	19
Latch.....	19
Removing the Latch.....	20
Installing the Mini PCIe Card.....	21
Installing the PCI and PCIe x1 Expansion Card.....	21
Connecting Cables to Terminal Blocks.....	22
Chapter 4 - Jumper Settings.....	23
Clear CMOS.....	23
PS/2 Power Select.....	23
USB Power Select.....	24
Power-on Select.....	24

COM 1 RS232/422/485 Select.....	25
COM 1 Signal Select.....	25
Front Audio or Audio Amplifier Select.....	26

Chapter 5 - Ports and Connectors..... 27

Front Panel I/O Port.....	27
USB Ports.....	27
Bottom Panel I/O Ports.....	28
PS/2 Mouse and PS/2 Keyboard Ports.....	28
RJ45 LAN Ports.....	29
USB Ports.....	29
Graphics Interface.....	30
COM (Serial) Ports.....	31
Audio.....	31
I/O Connectors.....	32
SATA (Serial ATA) Connectors.....	32
Digital I/O Connector and Digital I/O Power Connector.....	33
Audio Amplifier Connector.....	33
Chassis Intrusion Connector.....	34
Cooling Fan Connectors.....	34
Standby Power LED.....	35
Power Connectors.....	35
Expansion Slots.....	36
Front Panel Connectors.....	36
Battery.....	37
SDVO Connector.....	37
SDVO-LVDS Daughterboard (optional).....	38
Installing the SDVO-LVDS Daughterboard onto the Motherboard (optional).....	39

Chapter 6 - Mounting Options..... 42

Wall Mount.....	42
Panel Mount.....	43

Chapter 7 - BIOS Setup..... 45

Overview.....	45
AMI BIOS Setup Utility.....	46
Updating the BIOS.....	57

Chapter 8 - Supported Software..... 58

Chapter 9 - Audio Configuration..... 70

Appendix A - Smart Fan Setting Guide..... 72

Appendix B - Watchdog Sample Code..... 74

Appendix C - System Error Message..... 75

Appendix D - Troubleshooting Checklist..... 76

About this Manual

An electronic file of this manual is included in the CD. To view the user's manual in the CD, insert the CD into a CD-ROM drive. The autorun screen (Main Board Utility CD) will appear. Click "User's Manual" on the main menu.

Warranty

1. Warranty does not cover damages or failures that arised from misuse of the product, inability to use the product, unauthorized replacement or alteration of components and product specifications.
2. The warranty is void if the product has been subjected to physical abuse, improper installation, modification, accidents or unauthorized repair of the product.
3. Unless otherwise instructed in this user's manual, the user may not, under any circumstances, attempt to perform service, adjustments or repairs on the product, whether in or out of warranty. It must be returned to the purchase point, factory or authorized service agency for all such work.
4. We will not be liable for any indirect, special, incidental or consequential damages to the product that has been modified or altered.

Static Electricity Precautions

It is quite easy to inadvertently damage your PC, system board, components or devices even before installing them in your system unit. Static electrical discharge can damage computer components without causing any signs of physical damage. You must take extra care in handling them to ensure against electrostatic build-up.

1. To prevent electrostatic build-up, leave the system board in its anti-static bag until you are ready to install it.
2. Wear an antistatic wrist strap.
3. Do all preparation work on a static-free surface.
4. Hold the device only by its edges. Be careful not to touch any of the components, contacts or connections.
5. Avoid touching the pins or contacts on all modules and connectors. Hold modules or connectors by their ends.

Important:



Electrostatic discharge (ESD) can damage your processor, disk drive and other components. Perform the upgrade instruction procedures described at an ESD workstation only. If such a station is not available, you can provide some ESD protection by wearing an antistatic wrist strap and attaching it to a metal part of the system chassis. If a wrist strap is unavailable, establish and maintain contact with the system chassis throughout any procedures requiring ESD protection.

Safety Measures

To avoid damage to the system:

- Use the correct AC input voltage range.

To reduce the risk of electric shock:

- Unplug the power cord before removing the system chassis cover for installation or servicing. After installation or servicing, cover the system chassis before plugging the power cord.

Battery:

- Danger of explosion if battery incorrectly replaced.
- Replace only with the same or equivalent type recommend by the manufacturer.
- Dispose of used batteries according to local ordinance.

Safety Precautions

- Use the correct DC input voltage range.
- Unplug the power cord before removing the system chassis cover for installation or servicing. After installation or servicing, cover the system chassis before plugging the power cord.
- Danger of explosion if battery incorrectly replaced.
- Replace only with the same or equivalent type recommend by the manufacturer.
- Dispose of used batteries according to local ordinance.
- Keep this system away from humidity.
- Place the system on a stable surface. Dropping it or letting it fall may cause damage.
- The openings on the system are for air ventilation to protect the system from overheating. **DO NOT COVER THE OPENINGS.**
- Place the power cord in such a way that it will not be stepped on. Do not place anything on top of the power cord. Use a power cord that has been approved for use with the system and that it matches the voltage and current marked on the system's electrical range label.
- If the system will not be used for a long time, disconnect it from the power source to avoid damage by transient overvoltage.
- If one of the following occurs, consult a service personnel:
 - The power cord or plug is damaged.
 - Liquid has penetrated the system.
 - The system has been exposed to moisture.
 - The system is not working properly.
 - The system dropped or is damaged.
 - The system has obvious signs of breakage.
- The unit uses a three-wire ground cable which is equipped with a third pin to ground the unit and prevent electric shock. Do not defeat the purpose of this pin. If your outlet does not support this kind of plug, contact your electrician to replace the outlet.
- Disconnect the system from the DC outlet before cleaning. Use a damp cloth. Do not use liquid or spray detergents for cleaning.

About the Package

The package contains the following items. If any of these items are missing or damaged, please contact your dealer or sales representative for assistance.

- 1 12"/15"/17" Touch Panel PC
- 1 120W Power adapter (TPC121)
- 1 CD disk includes
 - Manual
 - Drivers
- 1 Quick Installation Guide

Optional Items

- Wall Mount kit
- Panel Mount kit
- Power Cord

The board and accessories in the package may not come similar to the information listed above. This may differ in accordance to the sales region or models in which it was sold. For more information about the standard package in your region, please contact your dealer or sales representative.

Before Using the System

Before powering-on the system, prepare the basic system components.

If you are installing the system board in a new system, you will need at least the following internal components.

- Memory module
- Storage devices such as hard disk drive, CD-ROM, etc.

You will also need external system peripherals you intend to use which will normally include at least a keyboard, a mouse and a video display monitor.

Chapter 1 - Introduction

Overview

TPC121



TPC150



TPC170



Key Features

	TPC121/150/170
Processor	3rd/2nd Generation Intel® Core™ processors
Chipset	Intel® H61 Express Chipset
LAN	2 LAN ports
COM	2 COM ports
Dual Displays	HDMI and DVI-I
USB	4 Type A USB 2.0/1.1 ports at the bottom 2 Type A USB 2.0/1.1 ports at the front panel
Audio	Mic-in, Line-in, Line-out 2 3W speakers
HDMI	1 HDMI port

Specifications

TPC121

Processor System	<ul style="list-style-type: none"> Processors: <ul style="list-style-type: none"> 3rd generation Intel® Core™ processors 2nd generation Intel® Core™ processors Supports up to 65W TDP Intel® H61 Express chipset
Memory	<ul style="list-style-type: none"> Two DDR3 1333/1600MHz SODIMM sockets (3rd generation processors) Two DDR3 1066/1333MHz SODIMM sockets (2nd generation processors) Supports up to 16GB system memory
LCD and Touch Screen	<ul style="list-style-type: none"> 12.1" 1024x768 TFT LCD panel with touch screen Supports 5-wire Resistive Touch 30,000 MTBF LED backlight Brightness (cd/m²): 500
Graphics	<ul style="list-style-type: none"> Intel® HD Graphics Display ports: HDMI and DVI-I HDMI and DVI-I display resolution up to 1920x1200
Storage	<ul style="list-style-type: none"> 1 2.5" SATA drive bay 1 optical drive bay (optional)
Ethernet	<ul style="list-style-type: none"> 1 Intel W82579LM Gigabit Ethernet Controllers 1 Intel W82574L Gigabit Ethernet Controllers
Audio	<ul style="list-style-type: none"> Realtek ALC886 5.1-channel High Definition Audio Two 3W speakers (left and right sides)
COM	<ul style="list-style-type: none"> 1 RS232/422/485 COM port 1 RS232 COM port
USB	<ul style="list-style-type: none"> 2 Type A USB 2.0/1.1 ports at the front panel 4 Type A USB 2.0/1.1 ports at the bottom
Power	<ul style="list-style-type: none"> Power input voltage <ul style="list-style-type: none"> 1 +19V DC-in jack or 16-30V 3-pole terminal block
Cooling System	<ul style="list-style-type: none"> Smart fan system control suitable for quiet environments
Environment	<ul style="list-style-type: none"> Temperature <ul style="list-style-type: none"> Operating: -10°C ~ 50°C Storage: -20°C ~ 60°C Relative Humidity <ul style="list-style-type: none"> 90% RH at 50°C, 1 week Corrosion <ul style="list-style-type: none"> 4 periods of 7 days at 50°C with 90-95% relative humidity after 2 hours salt spray or waiver
Vibration	<ul style="list-style-type: none"> Operating: 1G, 5~500Hz Non-operating: 1.5G, 5~25Hz IEC 68-2-64 compliant
Shock	<ul style="list-style-type: none"> Operating: 3G peak acceleration (11 msec. duration) Non-operating: 10G peak acceleration (11 msec. duration) IEC 68-2-27 compliant

I/O Ports	<ul style="list-style-type: none"> Front <ul style="list-style-type: none"> 2 Type A USB 2.0/1.1 ports 5 function keys 3 LED indicators: Power, HDD, Alarm 1 built-in antenna Bottom <ul style="list-style-type: none"> 1 DB-9 RS232/422/485 COM 1 DB-9 RS232 COM 1 PS/2 keyboard 1 PS/2 mouse 4 Type A USB 2.0/1.1 3 audio jacks: Mic-in, Line-in, Line-out 2 RJ45 LAN with LEDs 1 DVI-I 1 HDMI 1 power switch 1 +19V DC-in jack or 16-30V 3-pole terminal block
Expansion	<ul style="list-style-type: none"> 1 PCIe x1 and 1 PCI (X100-3PE2) 2 PCI (X100-2P1M) 2 Mini PCIe
Front Panel Protection	<ul style="list-style-type: none"> IP65 (Dust Tight; Water Proof protection)
Construction	<ul style="list-style-type: none"> Aluminum front bezel Rear panel: sheet metal
Mounting	<ul style="list-style-type: none"> VESA mount: 75x75 and 100x100 Wall mount bracket (option) Panel mount: mounting clamp (option)
Dimensions	<ul style="list-style-type: none"> 345mm x 265mm x 103mm (W x H x D)
Weight	<ul style="list-style-type: none"> 6.5 kg
OS Support	<ul style="list-style-type: none"> Windows XP Pro (WES2009) Windows Vista Windows 7 (WS7P) Windows 8 and Windows 8 Embedded Linux Ubuntu 13
Certification	<ul style="list-style-type: none"> CE FCC Class A RoHS

Specifications

TPC150

Processor System	<ul style="list-style-type: none"> Processors: <ul style="list-style-type: none"> 3rd generation Intel® Core™ processors 2nd generation Intel® Core™ processors Supports up to 65W TDP Intel® H61 Express chipset
Memory	<ul style="list-style-type: none"> Two DDR3 1333/1600MHz SODIMM sockets (3rd generation processors) Two DDR3 1066/1333MHz SODIMM sockets (2nd generation processors) Supports up to 16GB system memory
LCD and Touch Screen	<ul style="list-style-type: none"> 15" 1024x768 TFT LCD panel with touch screen Supports 5-wire Resistive Touch 50,000 MTBF LED backlight Brightness (cd/m²): 250
Graphics	<ul style="list-style-type: none"> Intel® HD Graphics Display ports: HDMI and DVI-I HDMI and DVI-I display resolution up to 1920x1200
Storage	<ul style="list-style-type: none"> 2 2.5" SATA drive bays 1 optical drive bay (optional)
Ethernet	<ul style="list-style-type: none"> 1 Intel W82579LM Gigabit Ethernet Controllers 1 Intel W82574L Gigabit Ethernet Controllers
Audio	<ul style="list-style-type: none"> Realtek ALC886 5.1-channel High Definition Audio Two 3W speakers (left and right sides)
COM	<ul style="list-style-type: none"> 1 RS232/422/485 COM port 1 RS232 COM port
USB	<ul style="list-style-type: none"> 2 Type A USB 2.0/1.1 ports at the front panel 4 Type A USB 2.0/1.1 ports at the bottom
Power	<ul style="list-style-type: none"> Power input voltage <ul style="list-style-type: none"> Standard: ATX power type, AC 100-240V, 3.5A, 250W Option: 24V DC-in 3-pole terminal block Available upon request: 12V and 30V DC-in 3-pole terminal block
Cooling System	<ul style="list-style-type: none"> Smart fan system control suitable for quiet environments
Environment	<ul style="list-style-type: none"> Temperature <ul style="list-style-type: none"> Operating: -10°C ~ 50°C Storage: -20°C ~ 60°C Relative Humidity <ul style="list-style-type: none"> 90% RH at 50°C, 1 week Corrosion <ul style="list-style-type: none"> 4 periods of 7 days at 50°C with 90-95% relative humidity after 2 hours salt spray or waiver
Vibration	<ul style="list-style-type: none"> Operating: 1G, 5~500Hz Non-operating: 1.5G, 5~25Hz IEC 68-2-64 compliant
Shock	<ul style="list-style-type: none"> Operating: 3G peak acceleration (11 msec. duration) Non-operating: 10G peak acceleration (11 msec. duration) IEC 68-2-27 compliant

I/O Ports	<ul style="list-style-type: none"> Front <ul style="list-style-type: none"> 2 Type A USB 2.0/1.1 ports 5 function keys 3 LED indicators: Power, HDD, Alarm 1 built-in antenna Bottom <ul style="list-style-type: none"> 1 DB-9 RS232/422/485 COM 1 DB-9 RS232 COM 1 PS/2 keyboard 1 PS/2 mouse 4 Type A USB 2.0/1.1 3 audio jacks: Mic-in, Line-in, Line-out 2 RJ45 LAN with LEDs 1 DVI-I 1 HDMI 1 power switch
Expansion	<ul style="list-style-type: none"> 1 PCIe x1 and 1 PCI (X100-3PE2) 2 PCI (X100-2P1M) 2 Mini PCIe <ul style="list-style-type: none"> Supports PCIe and USB signals for Wi-Fi module Supports half/full size Mini PCIe card
Front Panel Protection	<ul style="list-style-type: none"> IP65 (Dust Tight; Water Proof protection)
Construction	<ul style="list-style-type: none"> Aluminum front bezel Rear panel: sheet metal
Mounting	<ul style="list-style-type: none"> VESA mount: 75x75 and 100x100 Wall mount bracket (option) Panel mount: mounting clamp (option)
Dimensions	<ul style="list-style-type: none"> 410mm x 320mm x 106mm (W x H x D)
Weight	<ul style="list-style-type: none"> 9.6 kg
OS Support	<ul style="list-style-type: none"> Windows XP Pro (WES2009) Windows Vista Windows 7 (WS7P) Windows 8 and Windows 8 Embedded Q4 2012 Linux Ubuntu 13
Certification	<ul style="list-style-type: none"> CE FCC Class A RoHS

Specifications

TPC170

Processor System	<ul style="list-style-type: none"> Processors: <ul style="list-style-type: none"> 3rd generation Intel® Core™ processors 2nd generation Intel® Core™ processors Supports up to 65W TDP Intel® H61 Express chipset
Memory	<ul style="list-style-type: none"> Two DDR3 1333/1600MHz SODIMM sockets (3rd generation processors) Two DDR3 1066/1333MHz SODIMM sockets (2nd generation processors) Supports up to 16GB system memory
LCD and Touch Screen	<ul style="list-style-type: none"> 17" 1280x1024 TFT LCD panel with touch screen Supports 5-wire Resistive Touch 50,000 MTBF LED backlight Brightness (cd/m²): 380
Graphics	<ul style="list-style-type: none"> Intel® HD Graphics Display ports: HDMI and DVI-I HDMI and DVI-I display resolution up to 1920x1200
Storage	<ul style="list-style-type: none"> 2 2.5" SATA drive bays 1 optical drive bay (optional)
Ethernet	<ul style="list-style-type: none"> 1 Intel W82579LM Gigabit Ethernet Controllers 1 Intel W82574L Gigabit Ethernet Controllers
Audio	<ul style="list-style-type: none"> Realtek ALC886 5.1-channel High Definition Audio Two 3W speakers (left and right sides)
COM	<ul style="list-style-type: none"> 1 RS232/422/485 COM port 1 RS232 COM port
USB	<ul style="list-style-type: none"> 2 Type A USB 2.0/1.1 ports at the front panel 4 Type A USB 2.0/1.1 ports at the bottom
Power	<ul style="list-style-type: none"> Power input voltage <ul style="list-style-type: none"> Standard: ATX power type, AC 100-240V, 3.5A, 250W Option: 24V DC-in 3-pole terminal block Available upon request: 12V and 30V DC-in 3-pole terminal block
Cooling System	<ul style="list-style-type: none"> Smart fan system control suitable for quiet environments
Environment	<ul style="list-style-type: none"> Temperature <ul style="list-style-type: none"> Operating: -10°C ~ 50°C Storage: -20°C ~ 60°C Relative Humidity <ul style="list-style-type: none"> 90% RH at 50°C, 1 week Corrosion <ul style="list-style-type: none"> 4 periods of 7 days at 50°C with 90-95% relative humidity after 2 hours salt spray or waiver
Vibration	<ul style="list-style-type: none"> Operating: 1G, 5~500Hz Non-operating: 1.5G, 5~25Hz IEC 68-2-64 compliant
Shock	<ul style="list-style-type: none"> Operating: 3G peak acceleration (11 msec. duration) Non-operating: 10G peak acceleration (11 msec. duration) IEC 68-2-27 compliant

I/O Ports	<ul style="list-style-type: none"> Front <ul style="list-style-type: none"> 2 Type A USB 2.0/1.1 ports 5 function keys 3 LED indicators: Power, HDD, Alarm 1 built-in antenna Bottom <ul style="list-style-type: none"> 1 DB-9 RS232/422/485 COM 1 DB-9 RS232 COM 1 PS/2 keyboard 1 PS/2 mouse 4 Type A USB 2.0/1.1 3 audio jacks: Mic-in, Line-in, Line-out 2 RJ45 LAN with LEDs 1 DVI-I 1 HDMI 1 power switch
Expansion	<ul style="list-style-type: none"> 1 PCIe x1 and 1 PCI (X100-3PE2) 2 PCI (X100-2P1M) 2 Mini PCIe <ul style="list-style-type: none"> Supports PCIe and USB signals for Wi-Fi module Supports half/full size Mini PCIe card
Front Panel Protection	<ul style="list-style-type: none"> IP65 (Dust Tight; Water Proof protection)
Construction	<ul style="list-style-type: none"> Aluminum front bezel Rear panel: sheet metal
Mounting	<ul style="list-style-type: none"> VESA mount: 75x75 and 100x100 Wall mount bracket (option) Panel mount: mounting clamp (option)
Dimensions	<ul style="list-style-type: none"> 443mm x 363mm x 106mm (W x H x D)
Weight	<ul style="list-style-type: none"> 11.4 kg
OS Support	<ul style="list-style-type: none"> Windows XP Pro (WES2009) Windows Vista Windows 7 (WS7P) Windows 8 and Windows 8 Embedded Q4 2012 Linux Ubuntu 13
Certification	<ul style="list-style-type: none"> CE FCC Class A RoHS

Getting to Know the TPC121/150/170

Front View

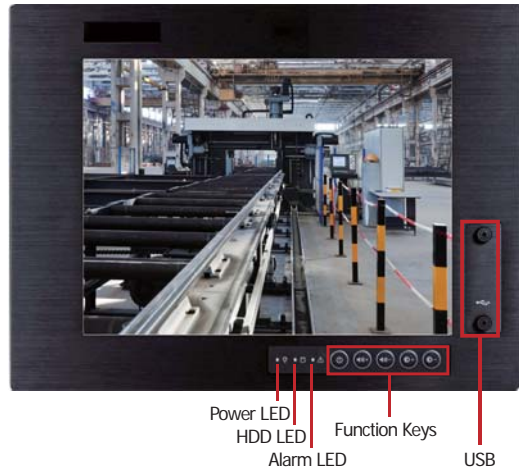

USB Ports

Used to connect USB 2.0/1.1 devices.

Function Keys

Used to navigate.

Alarm LED

Indicates the status when the CPU is over temperature.

HDD LED

Indicates the status of the hard drive.

Power LED

Indicates the power status of the system.

Bottom View

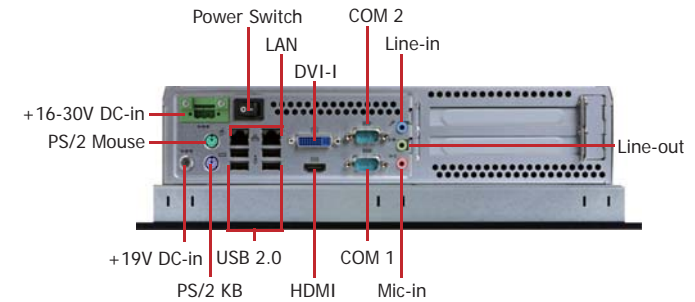

HDMI Port

Use to connect an HDMI device.

DVI-I Port

Used to connect a DVI device.

COM Ports

Used to connect serial devices.

USB Ports

Used to connect USB 2.0/1.1 devices.

LAN Ports

Used to connect the system to a local area network.

Line-out

Used to connect to a speaker.

Line-in

Used to connect any audio devices such as Hi-fi set, CD player, tape player, AM/FM radio tuner, synthesizer, etc.

Mic-in

Used to connect an external microphone.

PS/2 KB/Mouse

Used to connect a PS/2 keyboard and PS/2 mouse.

DC-in jack

Used to plug a power adapter.

Mechanical Dimensions

TPC121

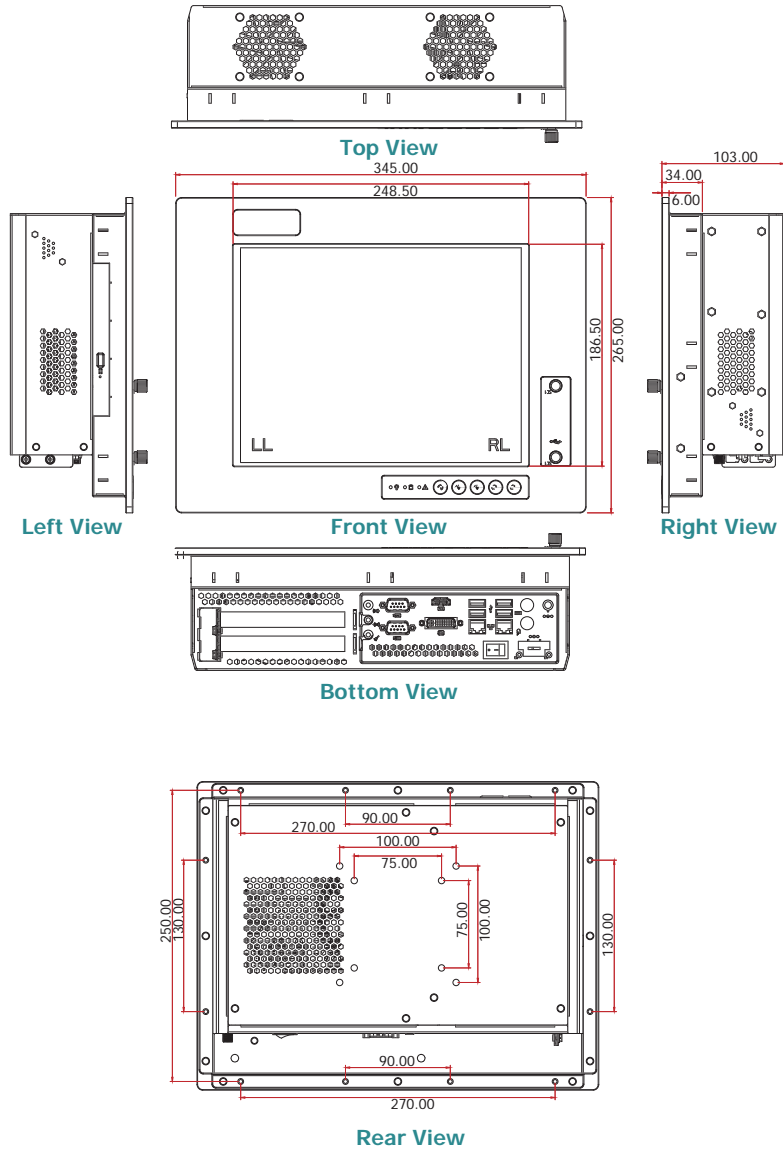

TPC150

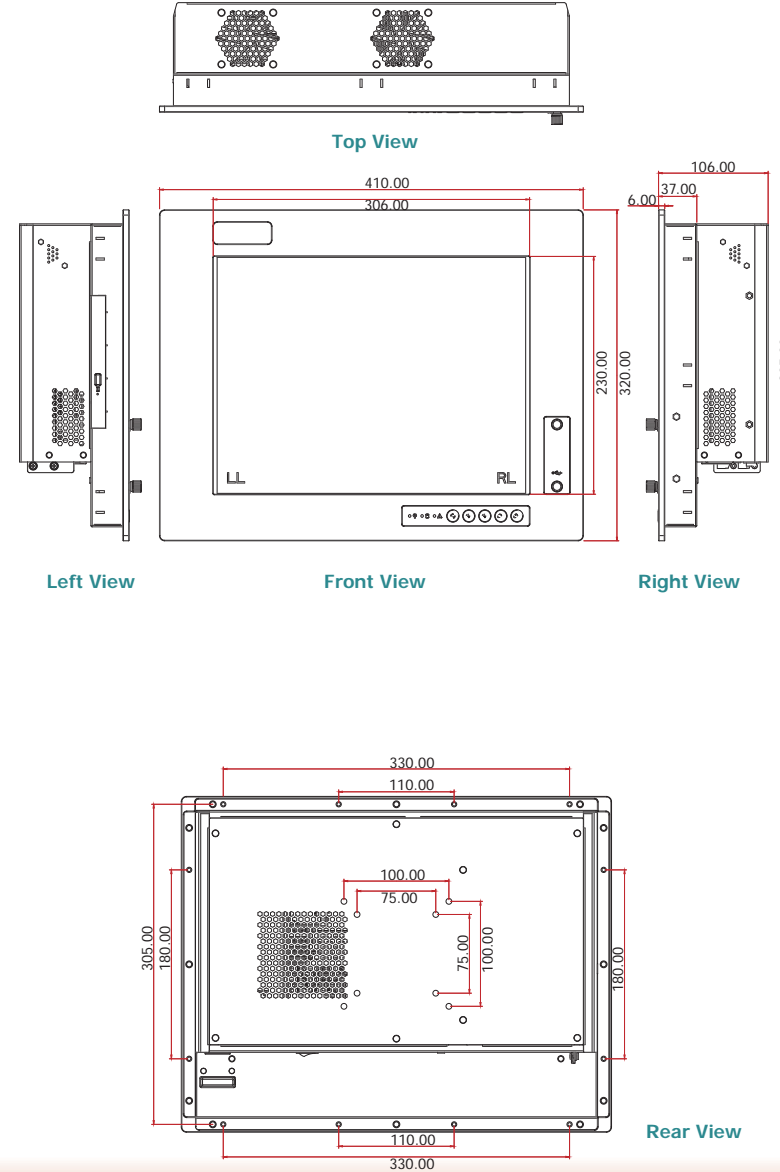

TPC170

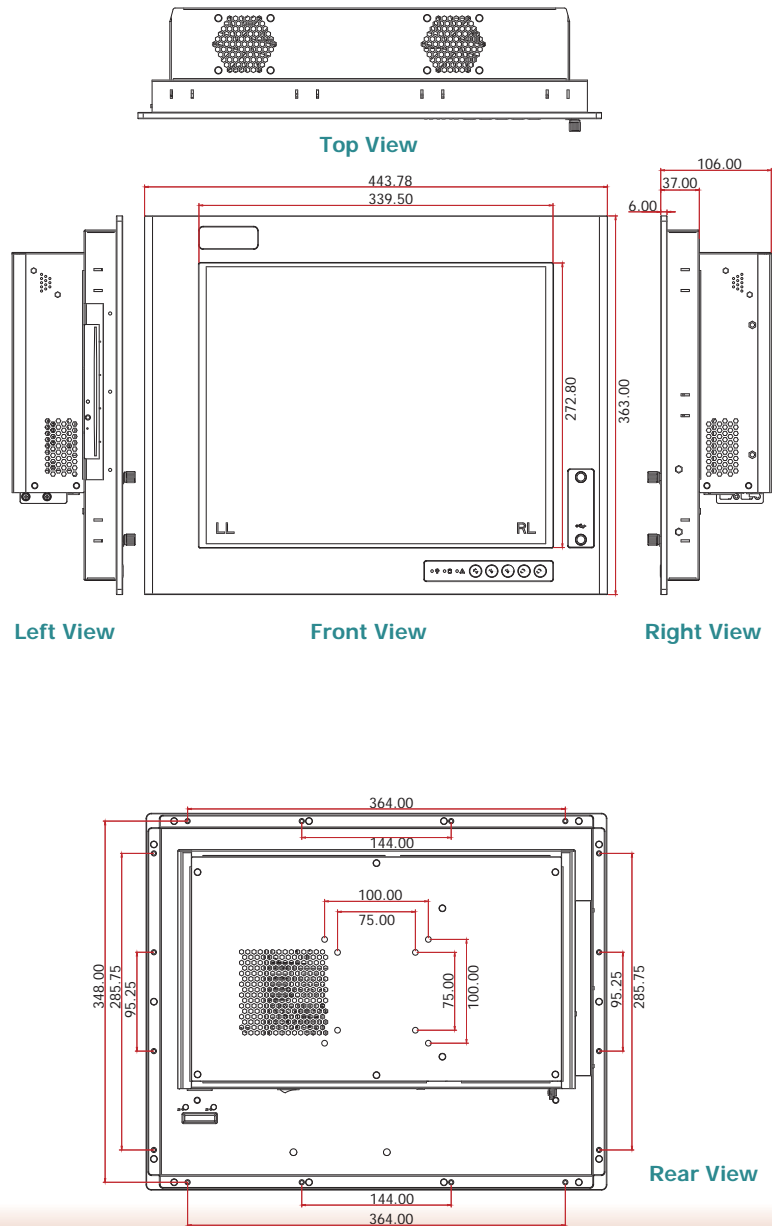

Motherboard Dimensions

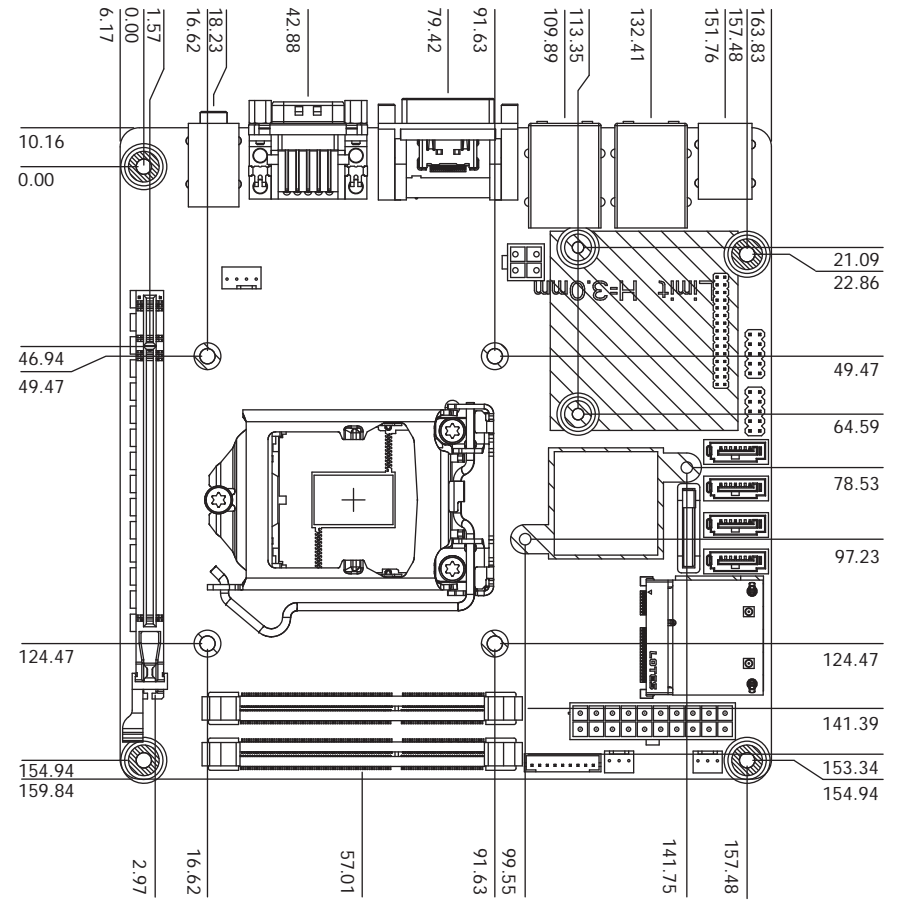

Chapter 2 - Getting Started

Preparing the System

Before you start using the system, you need the following items:

- SATA hard drive
- AC power adapter
- PS/2 or USB keyboard
- PS/2 or USB mouse
- CD-ROM drive (for installing software/drivers)
- Screwdriver
- Memory module (optional)

Installing Devices

The following are devices that can be installed in the TPC121/150/170 system.

- Memory module
- SATA hard drive
- Mini PCIe card

Configuring the BIOS

To get you started, you may need to change configurations such as the date, time and the type of hard disk drive.

1. Power-on the system.
2. After the memory test, the message "Press DEL to run setup" will appear on the screen. Press the Delete key to enter the AMI BIOS setup utility.

Installing the Operating System

Most operating system software are provided in a CD therefore you need to install a CD-ROM drive in order to use the CD.

Make sure a 2.5" SATA drive is already installed.

1. Refer to the following chapters for information on connecting a CD-ROM drive and installing a SATA drive.
2. Refer to your operating system manual for instructions on installing the operating system.

Installing the Drivers

The system package includes a CD disk. The CD includes drivers that must be installed to provide the best system performance. Refer to the Supported Software chapter for instructions on installing the drivers.

Chapter 3 - Installing Devices

Removing the Chassis Cover

1. Make sure the system and all other peripheral devices connected to it has been powered-off.
2. Disconnect all power cords and cables.
3. The 8 mounting screws on the rear side of the system are used to secure the cover to the chassis. Remove these screws and then put them in a safe place for later use.

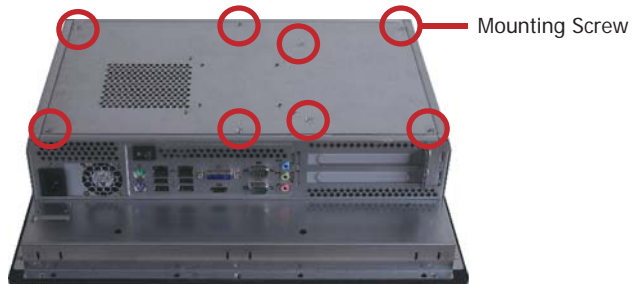

4. After removing the mounting screws, lift the cover up.



5. The memory socket, expansion slots, Mini PCIe slot and SATA drive bay are readily accessible after removing the chassis cover.

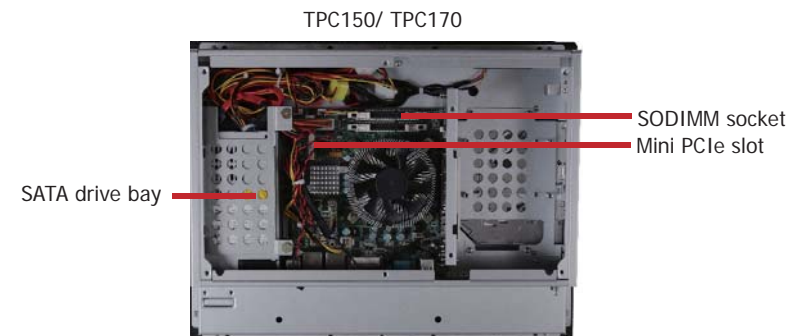
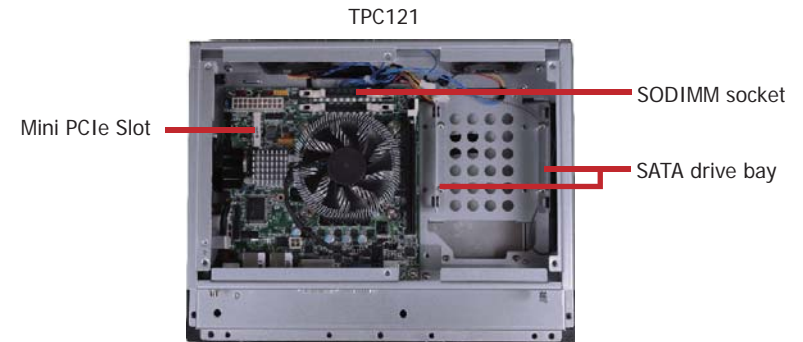

Installing an SODIMM

1. Locate the DIMM socket on the system board.

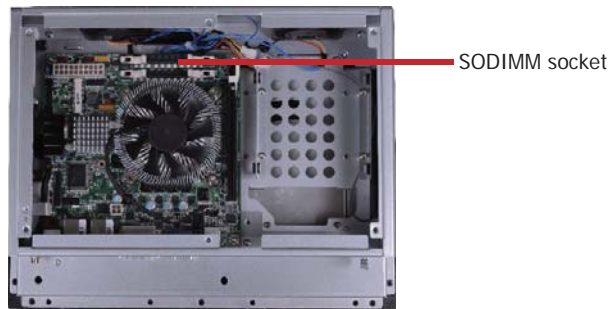

2. Push the ejector tabs which are at the ends of the socket at the side.



3. Note the key on the socket. The key ensures the module can be plugged into the socket in only one direction.

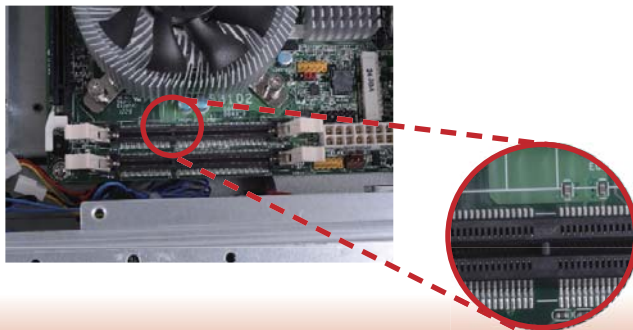

4. Grasping the module by its edges, position the module above the socket with the notch in the socket aligned with the key on the module. Apply firm even pressure to each end of the module until it slips down into the socket. The contact fingers on the edge of the module will almost completely disappear inside the socket.

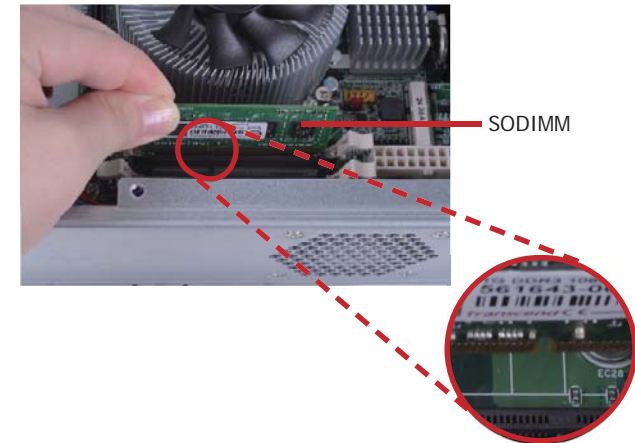

5. Push the module down until the clips at each end of the socket lock into position. You will hear a distinctive "click", indicating the module is correctly locked into position.

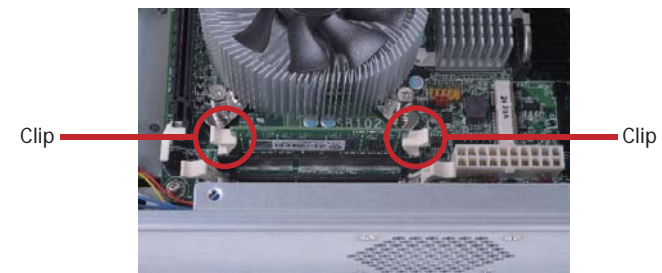

Installing a SATA Drive

1. Locate the SATA drive bay in the chassis.

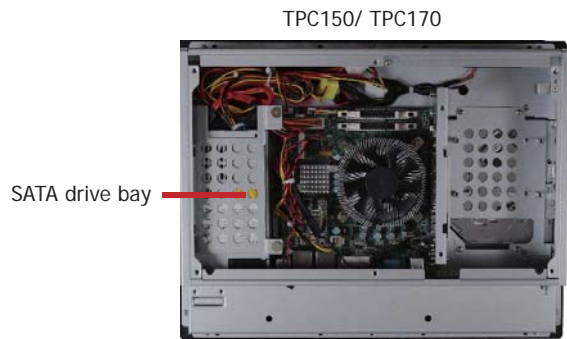
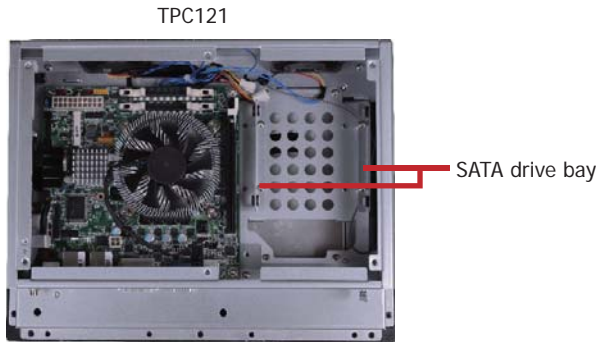

2. Remove the mounting screws that secure the HDD bracket to the drive bay.

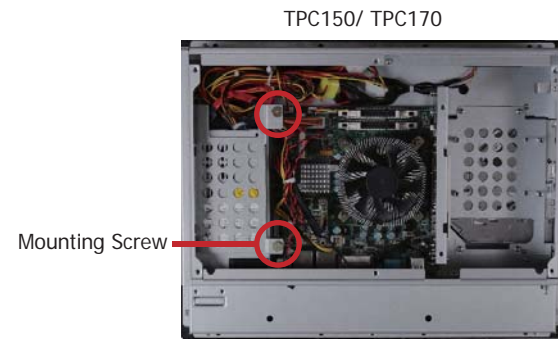
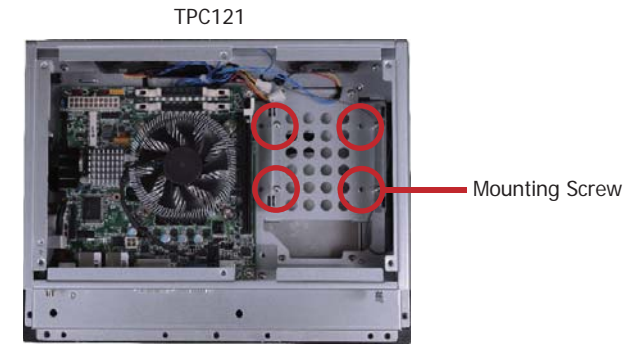

3. Align the mounting holes of the SATA drive with the mounting holes on the HDD bracket and then use the provided mounting screws to secure the drive in place.

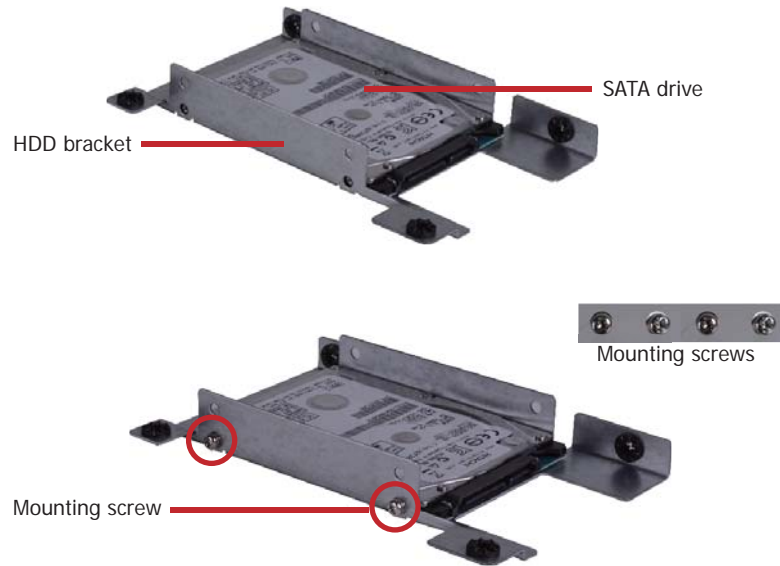

4. Place the SATA drive (with HDD bracket) back into place. Align the mounting holes on the HDD bracket with the mounting holes on the SATA drive bay and then use the provided mounting screws to secure the drive in place.

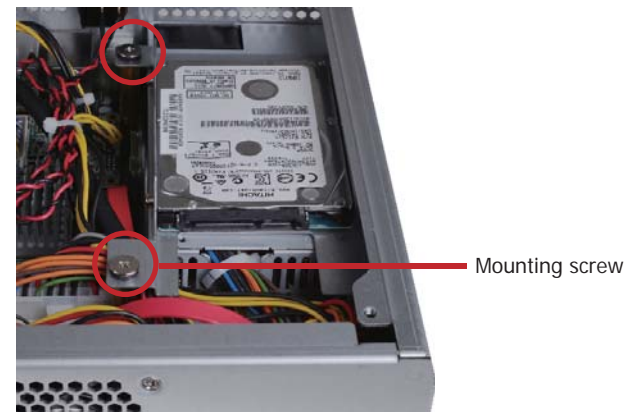

5. Connect one end to the SATA data connector on the SATA drive and the other end to the SATA data connector on the system board.



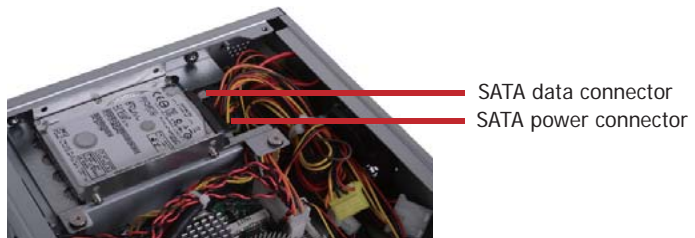
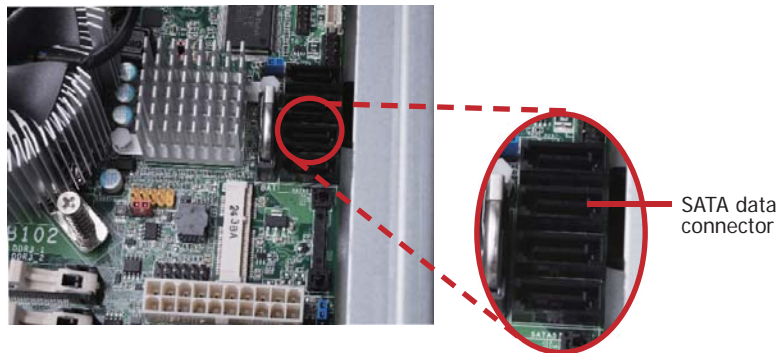
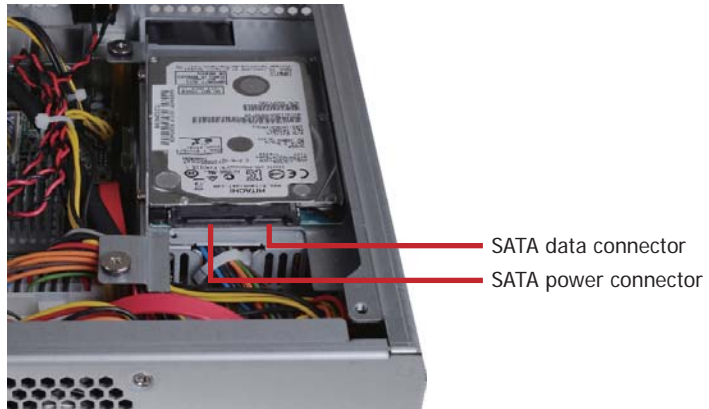

Installing a Mini PCIe Card

Latch

1. Locate the two Mini PCIe slots on the chassis.

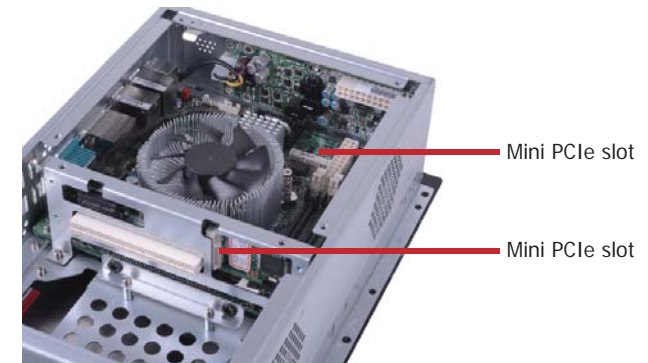

2. The latch is used to lock the Mini PCIe card into position. Insert the latch into the mounting holes and then push the latch down until the clips at each end of the latch lock into position. You will hear a distinctive "click", indicating the latch is correctly locked into position.



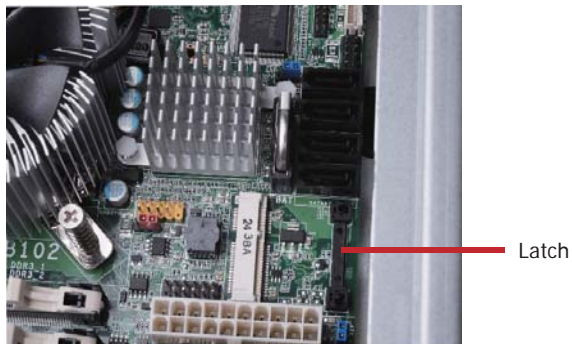
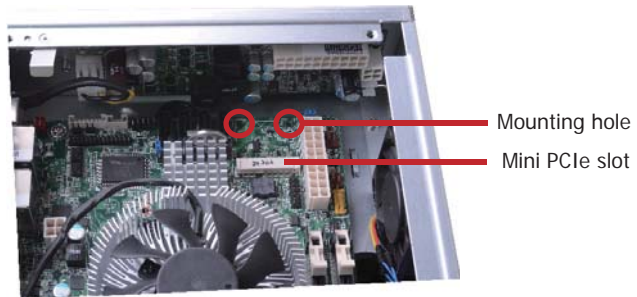

3. The system board is equipped with a Mini PCIe slot. The Mini PCIe slot supports half length Mini PCIe card. Note the key on the slot. The key ensures the Mini PCIe card can be plugged into the slot in only one direction.

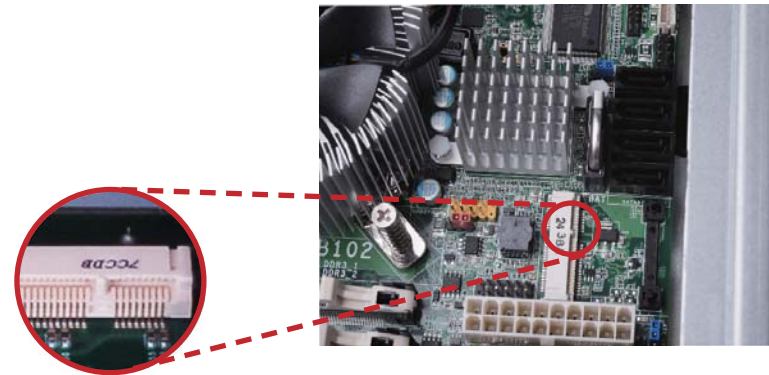

Removing the Latch

If you want to move the latch in order to use the desired card, please follow below steps:

1. Remove the clips at each end of the latch once at a time.
2. Press the clips to the center of the latch and pull it up.

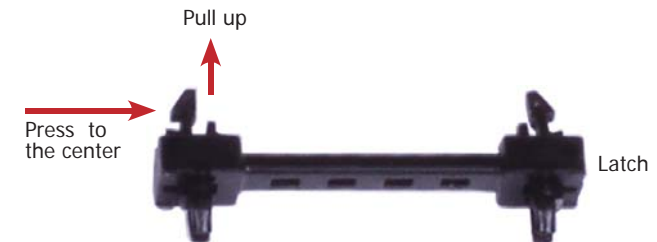

3. Pull the clips up and remove the latch.

Installing the Mini PCIe Card

1. Grasping the Mini PCIe card by its edges, align the card into the slot at an approximately 30 degrees angle. Apply firm even pressure to each end of the card until it slips down into the slot. The contact fingers on the edge of the card will almost completely disappear inside the slot.



2. Push the Mini PCIe card down until the clips at each end of the latch lock into position. You will hear a distinctive “click”, indicating the card is correctly locked into position.

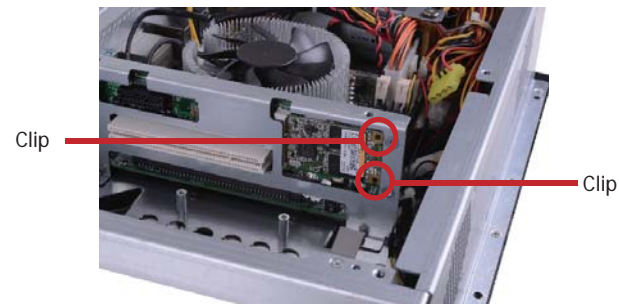

Installing the PCI and PCIe x1 Expansion Card

1. The PCI and PCIe x1 slots on the riser card are used to install the expansion cards. To install the expansion cards, you need to remove the mounting screws that secure the brackets to the chassis then remove the brackets.

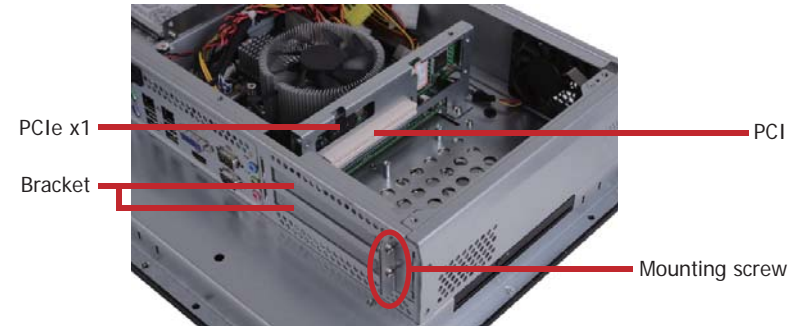

2. Remove these mounting screws and brackets, and then put them in a safe place for later use.

3. Insert the Expansion card with a bracket into the slot that is on the riser card. Replace the screw you removed in step 2 to secure the bracket in place.



Note:

The Expansion card used in the illustration above may not resemble the actual card. These illustrations are for reference only.

Connecting Cables to Terminal Blocks

1. Insert the cable end of the power adaptor to the terminal block. To firmly fix the cable into the terminal block, use a screwdriver to clamp down the wires to the screw that is in the terminal block.

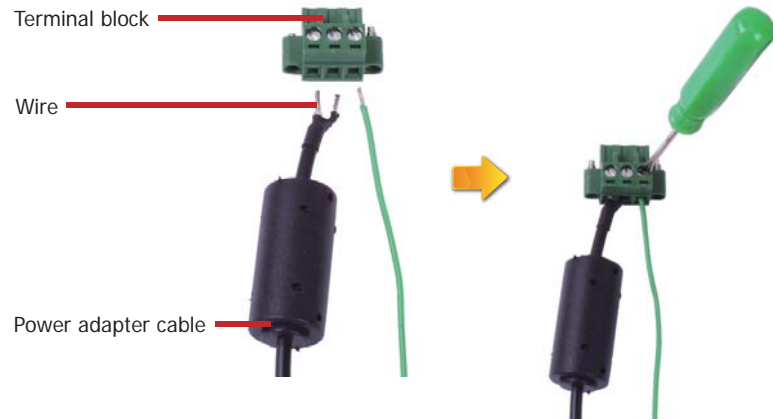

2. Plug the terminal block into the DC-in connector and then tighten the screws to secure the terminal block in place.

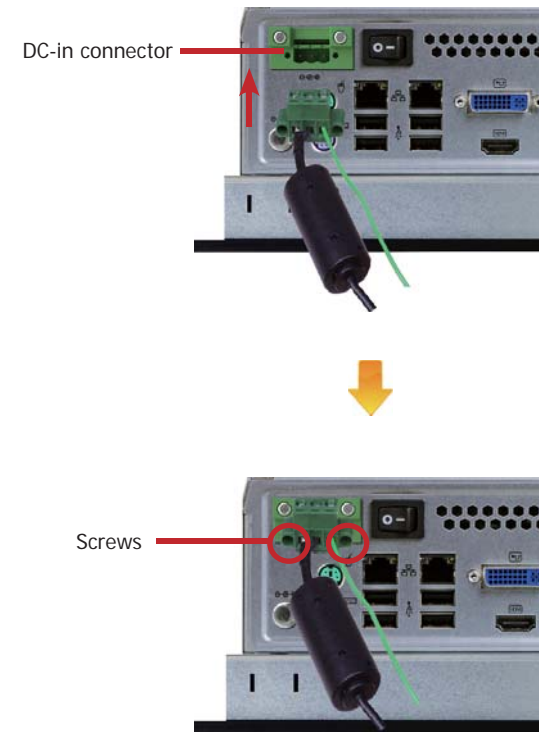

Chapter 4 - Jumper Settings

Clear CMOS

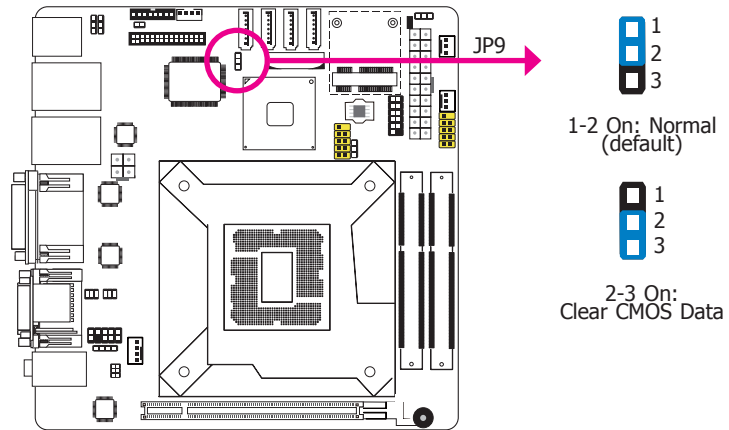

If you encounter the following,

- CMOS data becomes corrupted.
- You forgot the supervisor or user password.

you can reconfigure the system with the default values stored in the ROM BIOS.

To load the default values stored in the ROM BIOS, please follow the steps below.

- Power-off the system and unplug the power cord.
- Set JP9 pins 2 and 3 to On. Wait for a few seconds and set JP9 back to its default setting, pins 1 and 2 On.
- Now plug the power cord and power-on the system.

PS/2 Power Select

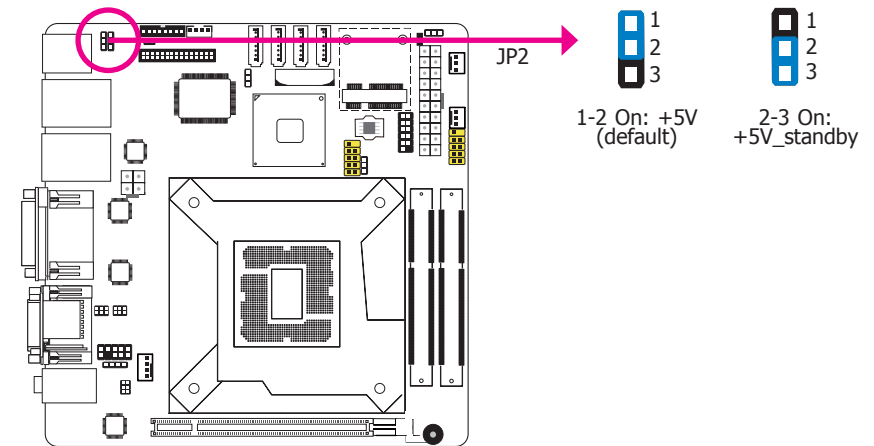

JP2 is used to select the power of the PS/2 keyboard and PS/2 mouse ports. Selecting +5V_standby will allow you to use the PS/2 keyboard or PS/2 mouse to wake up the system.



Important:

The +5VSB power source of your power supply must support $\geq 720\text{mA}$.

USB Power Select

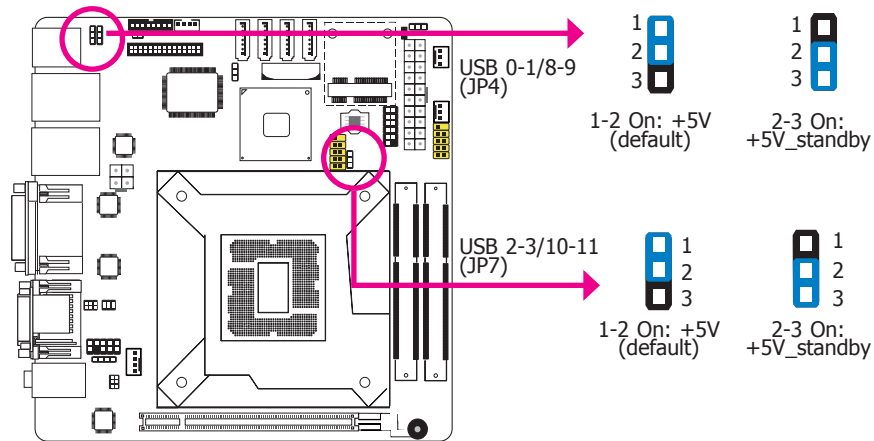

These jumpers are used to select the power of the USB ports. Selecting +5V_standby will allow you to use a USB device to wake up the system.



Important:

If you are using the Wake-On-USB Keyboard/Mouse function for 2 USB ports, the +5V_standby power source of your power supply must support $\geq 1.5A$. For 3 or more USB ports, the +5V_standby power source of your power supply must support $\geq 2A$.

Power-on Select

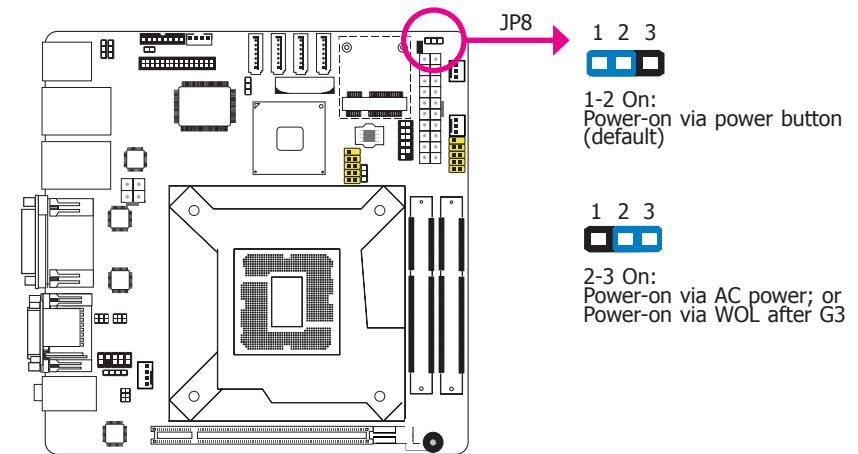

To power-on via WOL after G3:

1. Set JP8 pins 2 and 3 to On.
2. Set the "After G3" field to **Power Off/WOL**.
3. Set the "GbE Wake Up From S5" to **Enabled**.

The BIOS fields are in the "South Bridge Configuration" submenu (Chipset menu) of the AMI BIOS utility.

To power-on via AC Power:

1. Set JP8 pins 2 and 3 to On.
2. Set the "After G3" field to **Power On**.

COM 1 RS232/RS422/RS485 Select

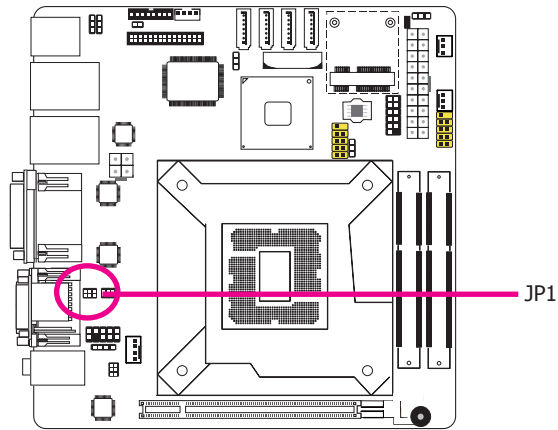

JP1 (for COM 1) is used to configure the COM port to RS232, RS422 (Full Duplex) or RS485. The pin function of the COM ports will vary according to the jumper's setting.

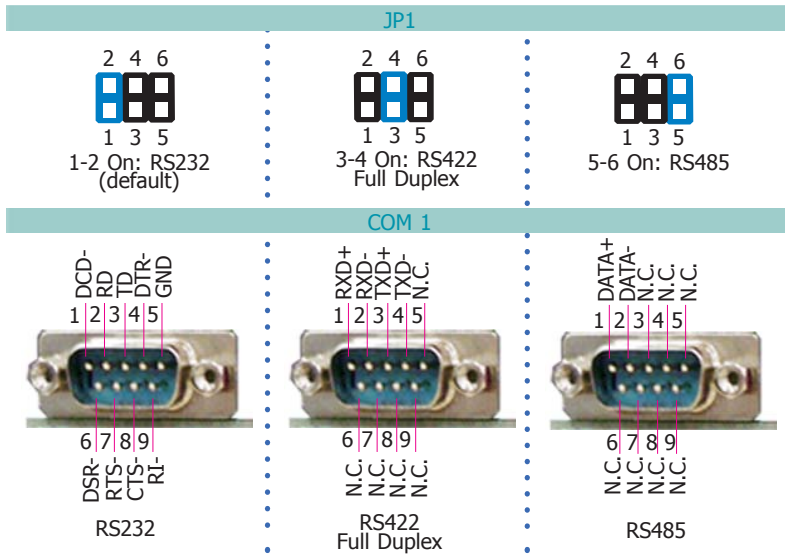

COM 1 Signal Select

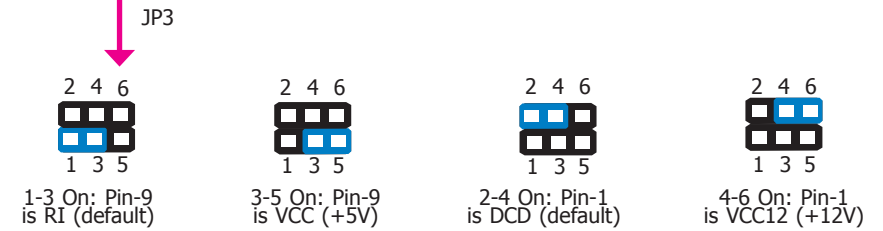
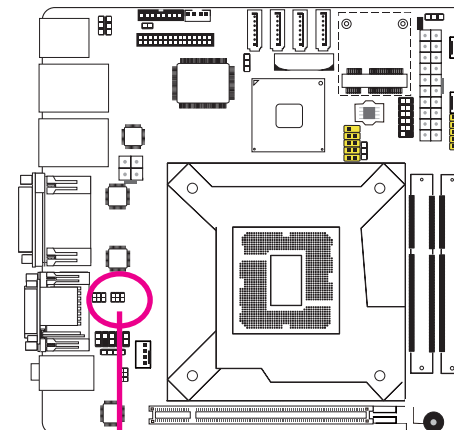

JP3 (for COM 1) is used to configure pin 1 and pin 9 signal of the COM port. The pin function of the COM ports will vary according to the jumper's setting.

Front Audio or Audio Amplifier Select

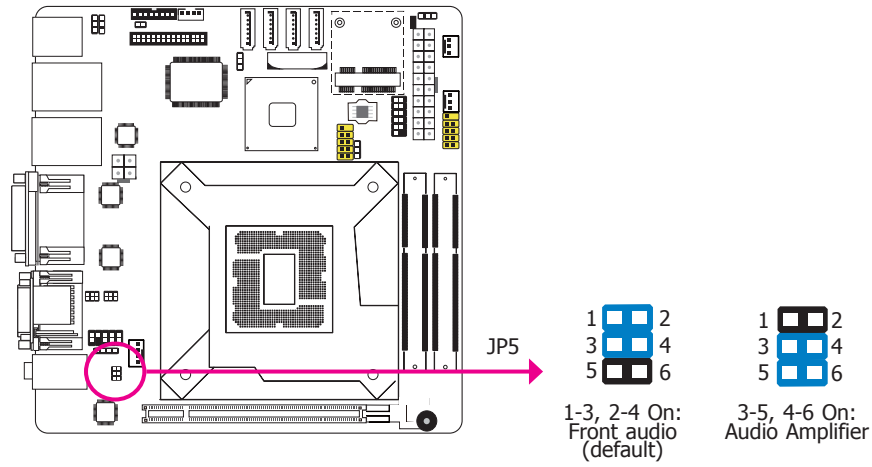

JP5 is used to configure front audio or audio amplifier select.

Chapter 5 - Ports and Connectors

Front Panel I/O Port



The front panel I/O port consists of the following:

- 2 USB ports

USB Ports



USB allows data exchange between your computer and a wide range of simultaneously accessible external Plug and Play peripherals.

The system board is equipped with 2 USB 2.0/1.1 ports.

- **BIOS Setting**

Configure the onboard USB in the Advanced menu ("USB Configuration" submenu) of the BIOS. Refer to chapter 7 for more information.

- **Wake-On-USB Keyboard/Mouse**

The Wake-On-USB Keyboard/Mouse function allows you to use a USB keyboard or USB mouse to wake up a system from the S3 (STR - Suspend To RAM) state. To use this function:

- **Jumper Setting**

JP6 must be set to "2-3 On: +5V_standby". Refer to "USB Power Select" in this chapter for more information.



Important:

If you are using the Wake-On-USB Keyboard/Mouse function for 2 USB ports, the +5V_standby power source of your power supply must support $\geq 1.5A$. For 3 or more USB ports, the +5V_standby power source of your power supply must support $\geq 2A$.

Bottom Panel I/O Ports

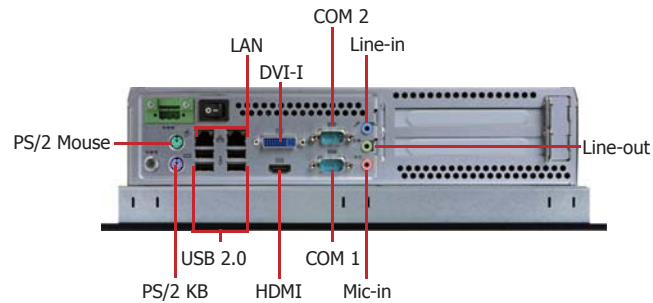

The bottom panel I/O ports consist of the following:

- 1 PS/2 Keyboard port
- 1 PS/2 Mouse port
- 2 LAN ports
- 4 USB 2.0 ports
- 1 DVI port
- 1 HDMI port
- 1 RS232/422/485 COM port
- 1 RS232 COM port
- 1 Line-in jack
- 1 Line-out jack
- 1 Mic-in jack

PS/2 Mouse and PS/2 Keyboard Ports

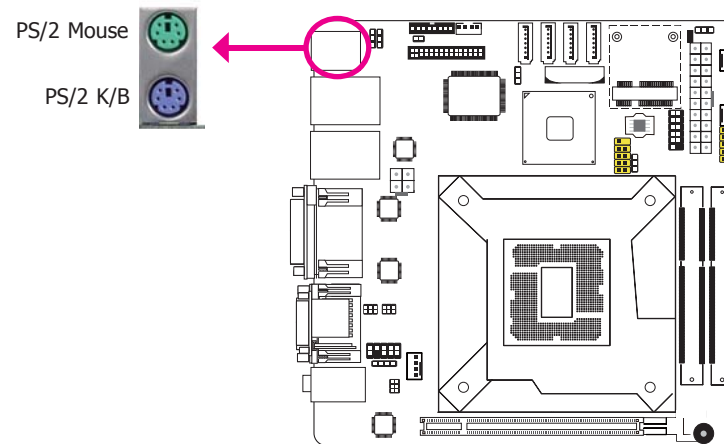

These ports are used to connect a PS/2 mouse and a PS/2 keyboard. The PS/2 mouse port uses IRQ12.

Wake-On-PS/2 Keyboard/Mouse

The Wake-On-PS/2 Keyboard/Mouse function allows you to use the PS/2 keyboard or PS/2 mouse to power-on the system. To use this function:

- **Jumper Setting**

JP2 must be set to "2-3 On: +5V_standby". Refer to "PS/2 Power Select" in this chapter for more information.

- **BIOS Setting**

Configure the PS/2 keyboard/mouse wake up function in the Advanced menu ("ACPI Power Management Configuration" submenu) of the BIOS. Refer to chapter 7 for more information.



Important:

The +5V_standby power source of your power supply must support $\geq 720\text{mA}$.

RJ45 LAN Ports

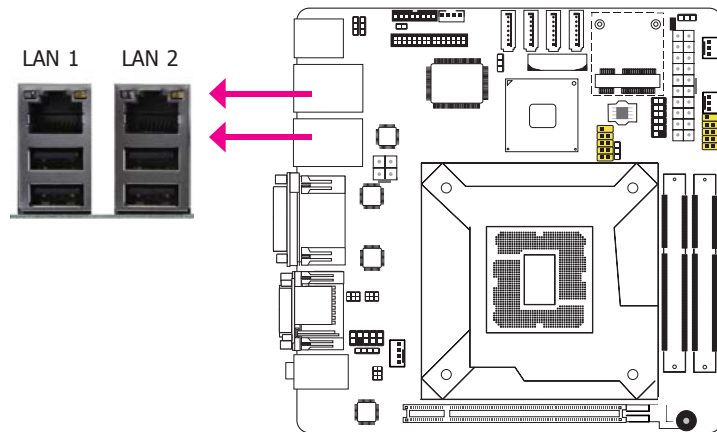

Features

- Intel W82579LM Gigabit Ethernet controller
- Intel W82574L PCI Express Gigabit Ethernet controller

The LAN ports allow the system board to connect to a local area network by means of a network hub.

BIOS Setting

Configure the onboard LAN in the Chipset menu ("South Bridge Configuration" submenu) of the BIOS. Refer to chapter 7 for more information.

Driver Installation

Install the LAN drivers. Refer to chapter 8 for more information.

USB Ports

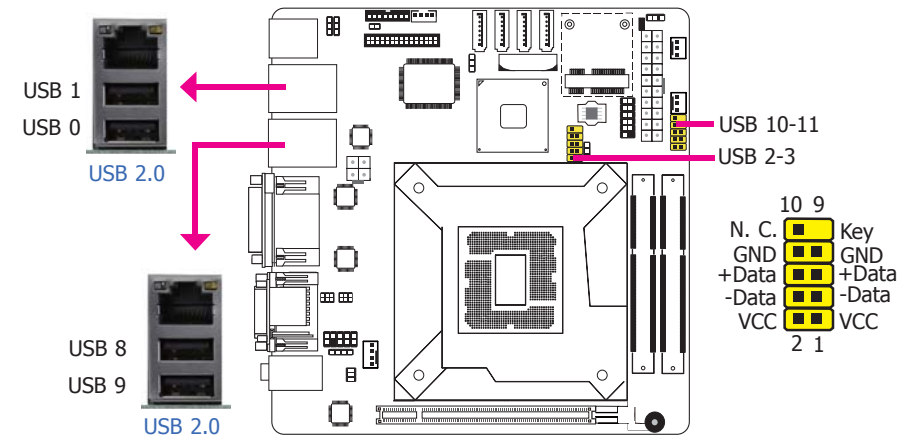

USB allows data exchange between your computer and a wide range of simultaneously accessible external Plug and Play peripherals.

The system board is equipped with four onboard USB 2.0/1.1 ports (USB 0-1/ 8-9). The two 10-pin connectors allow you to connect 4 additional USB 2.0/1.1 ports (USB 2-3/ 10-11). The additional USB ports may be mounted on a card-edge bracket. Install the card-edge bracket to an available slot at the rear of the system chassis and then insert the USB port cables to a connector.

BIOS Setting

Configure the onboard USB in the Advanced menu ("USB Configuration" submenu) of the BIOS. Refer to chapter 7 for more information.

Driver Installation

You may need to install the proper drivers in your operating system to use the USB device. Refer to your operating system's manual or documentation for more information.

Wake-On-USB Keyboard/Mouse

The Wake-On-USB Keyboard/Mouse function allows you to use a USB keyboard or USB mouse to wake up a system from the S3 (STR - Suspend To RAM) state. To use this function:

- **Jumper Setting**

JP6 must be set to "2-3 On: +5V_standby". Refer to "USB Power Select" in this chapter for more information.



Important:

If you are using the Wake-On-USB Keyboard/Mouse function for 2 USB ports, the +5V_standby power source of your power supply must support $\geq 1.5A$. For 3 or more USB ports, the +5V_standby power source of your power supply must support $\geq 2A$.

Graphics Interface

The display ports consist of the following:

- HDMI
- DVI-I port

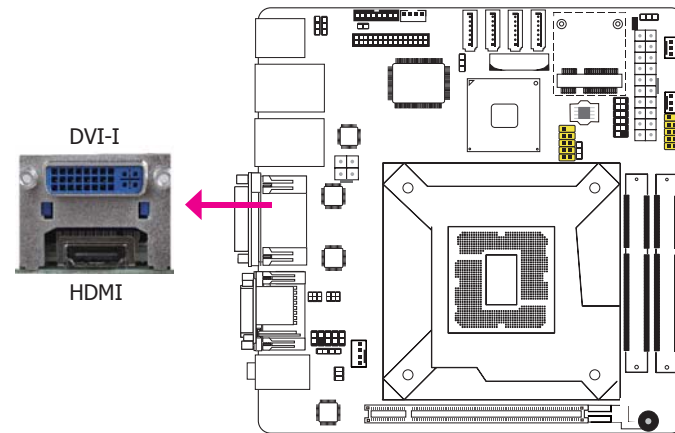

HDMI Port

The HDMI port which carries both digital audio and video signals is used to connect a LCD monitor or digital TV that has the HDMI port.

DVI-I Port

The DVI-I port is used to connect an LCD monitor. Connect the display device's cable connector to the DVI-I port. After you plug the cable connector into the port, gently tighten the cable screws to hold the connector in place.

BIOS Setting

Configure the display device in the Chipset menu ("North Bridge Configuration" submenu) of the BIOS. Refer to chapter 7 for more information.

COM (Serial) Ports

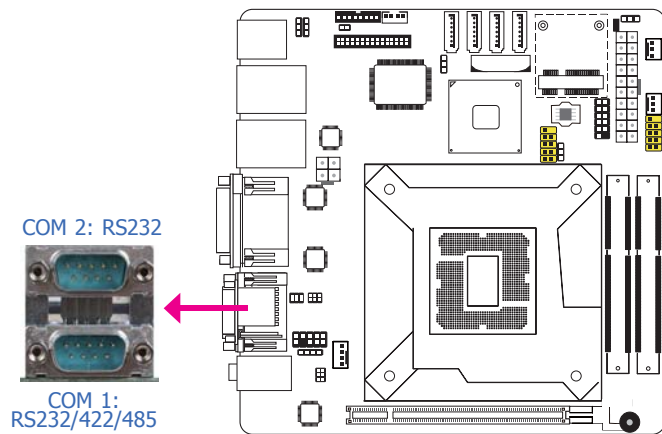

The pin function of COM 1 port will vary according to JP1's setting. Refer to "COM1 RS232/RS422/RS485 Select" in this chapter for more information.

The serial ports are asynchronous communication ports with 16C550A-compatible UARTs that can be used with modems, serial printers, remote display terminals, and other serial devices.

Connecting External Serial Ports

Your COM port may come mounted on a card-edge bracket. Install the card-edge bracket to an available slot at the rear of the system chassis then insert the serial port cable to the COM connector. Make sure the colored stripe on the ribbon cable is aligned with pin 1 of the COM connector.

BIOS Setting

Configure the serial ports in the Advanced menu ("Super IO Configuration" submenu) of the BIOS. Refer to chapter 7 for more information.

Audio

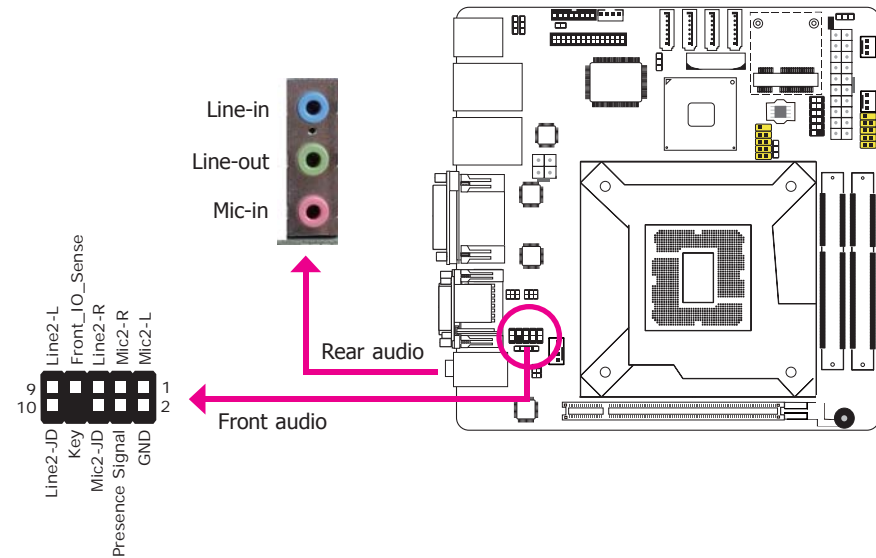

Rear Audio

The system board is equipped with 3 audio jacks. A jack is a one-hole connecting interface for inserting a plug.

- Mic-in Jack (Pink)
This jack is used to connect an external microphone.
- Line-in Jack (Light Blue)
This jack is used to connect any audio devices such as Hi-fi set, CD player, tape player, AM/FM radio tuner, synthesizer, etc.
- Line-out Jack (Lime)
This jack is used to connect a headphone or external speakers.

Front Audio

The front audio connector allows you to connect to the second line-out and mic-in jacks that are at the front panel of your system.

BIOS Setting

Configure the onboard audio in the Chipset menu ("South Bridge" submenu) of the BIOS. Refer to chapter 3 for more information.

Driver Installation

Install the audio driver. Refer to chapter 8 for more information.

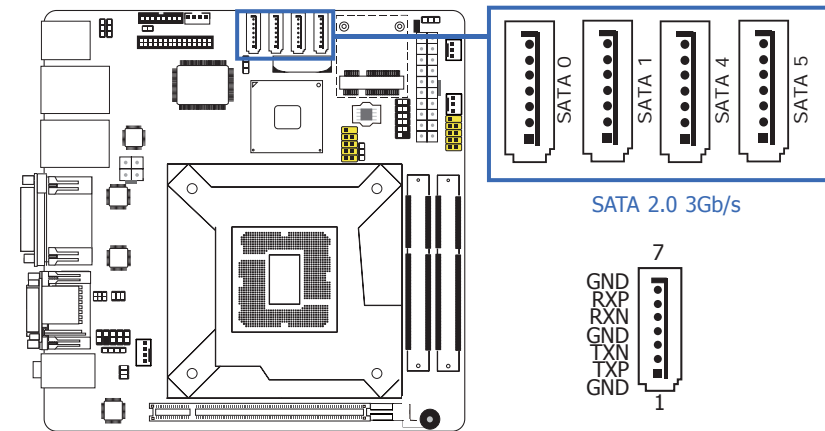
I/O Connectors**SATA (Serial ATA) Connectors****Features**

- Serial ATA ports
 - 4 SATA 2.0 ports with data transfer rate up to 3Gb/s

The Serial ATA connectors are used to connect Serial ATA devices. Connect one end of the Serial ATA cable to a SATA connector and the other end to your Serial ATA device.

BIOS Setting

Configure the Serial ATA drives in the Advanced menu ("SATA Configuration" submenu) of the BIOS. Refer to chapter 7 for more information.

Digital I/O Connector

Digital I/O Power Connector

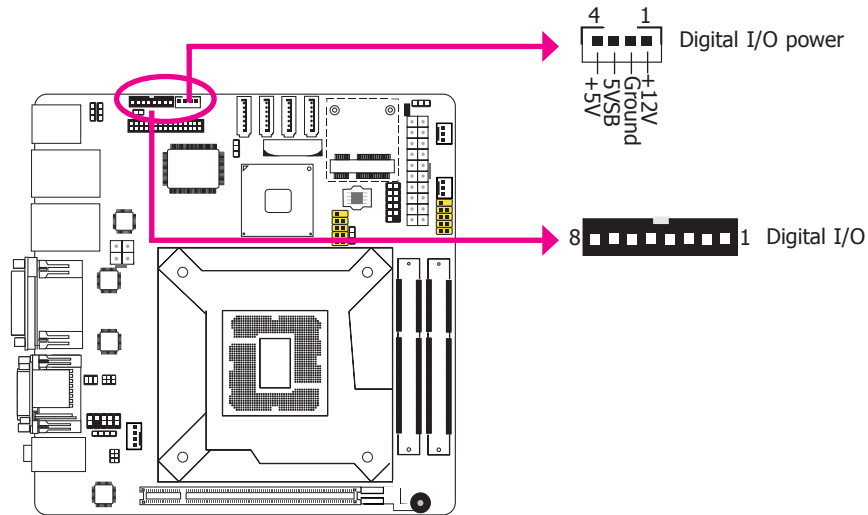

The 8-bit Digital I/O connector provides powering-on function to external devices that are connected to these connectors.

Digital I/O Connector

Pins	Function
1	DIO7
2	DIO6
3	DIO5
4	DIO4
5	DIO3
6	DIO2
7	DIO1
8	DIO0

Audio Amplifier Connector

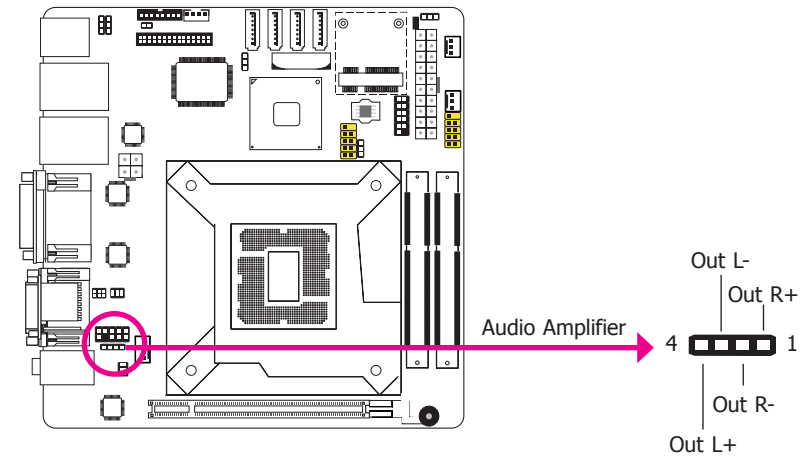

The audio amplifier connector which has amplifying feature is used to connect external speakers. Use the same signal cable to connect with an external speaker.

Chassis Intrusion Connector

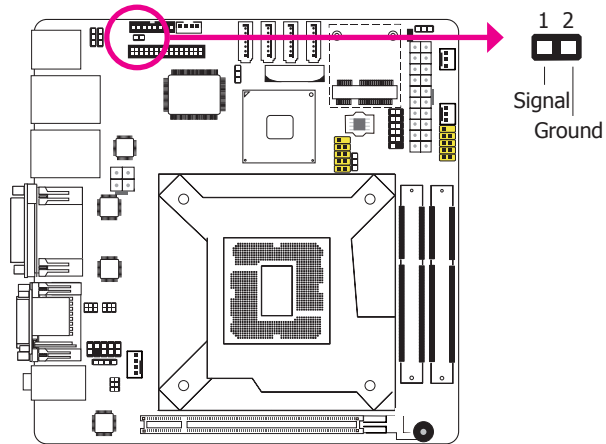

The board supports the chassis intrusion detection function. Connect the chassis intrusion sensor cable from the chassis to this connector. When the system's power is on and a chassis intrusion occurred, an alarm will sound. When the system's power is off and a chassis intrusion occurred, the alarm will sound only when the system restarts.

MyGuard Hardware Monitor

Install the "MyGuard Hardware Monitor" utility. By default, the chassis intrusion detection function is disabled. When enabled, a warning message will appear when the chassis is open. The utility can also be configured so that a beeping alarm will sound when the chassis is open. Refer to the "MyGuard Hardware Monitor" section in chapter 8 for more information.

Cooling Fan Connectors

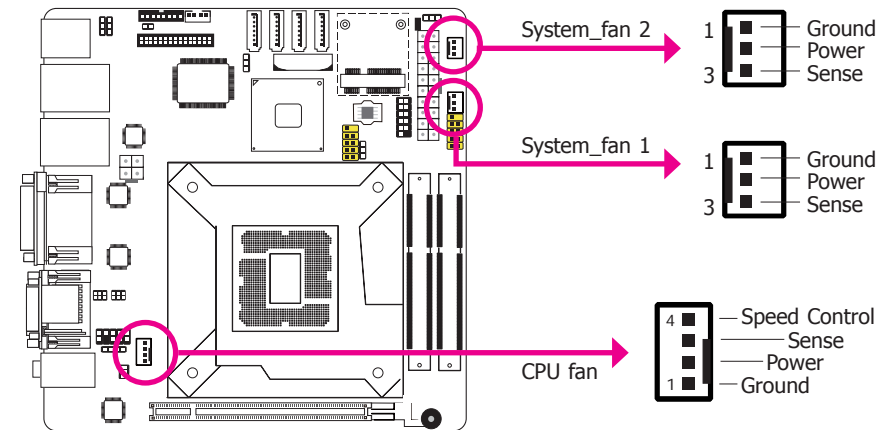

The fan connectors are used to connect cooling fans. The cooling fans will provide adequate airflow throughout the chassis to prevent overheating the CPU and system board components.

BIOS Setting

The Advanced menu ("PC Health Configuration" submenu) of the BIOS will display the current speed of the cooling fans. Refer to chapter 7 for more information.

Standby Power LED

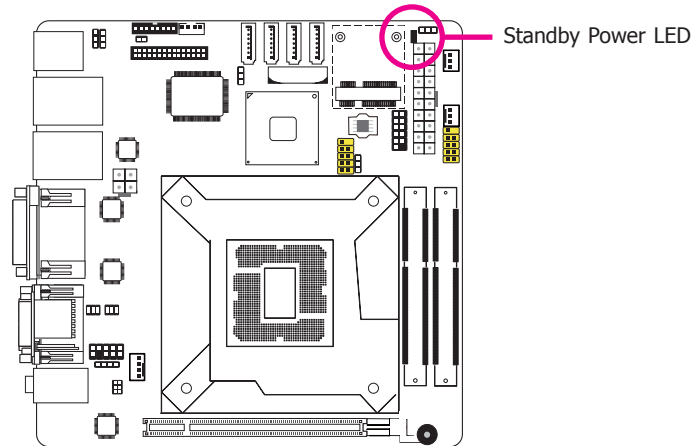

This LED will lit red when the system is in the standby mode. It indicates that there is power on the system board. Power-off the PC and then unplug the power cord prior to installing any devices. Failure to do so will cause severe damage to the motherboard and components.

Power Connectors

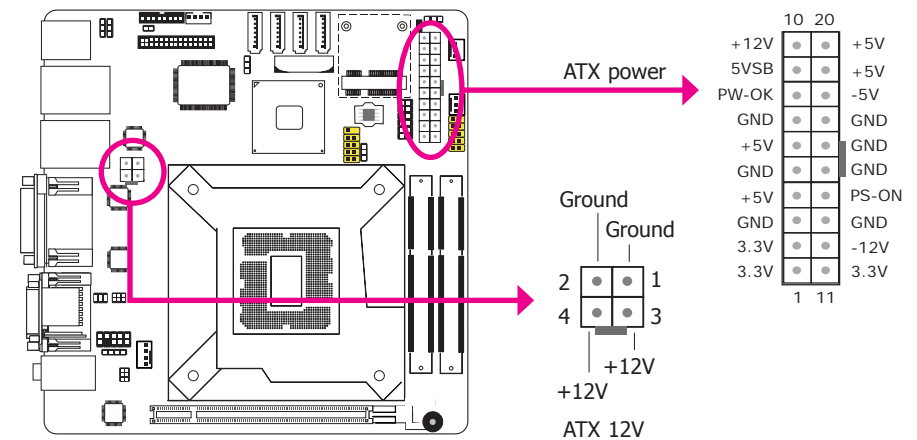

Use a power supply that complies with the ATX12V Power Supply Design Guide Version 1.1. An ATX12V power supply unit has a standard 20-pin ATX main power connector that must be inserted into the 20-pin connector. The 4-pin +12V power connector enables the delivery of more +12VDC current to the processor's Voltage Regulator Module (VRM).

The power connectors from the power supply unit are designed to fit the 20-pin and 4-pin connectors in only one orientation. Make sure to find the proper orientation before plugging the connectors.

The system board requires a minimum of 300 Watt power supply to operate. Your system configuration (CPU power, amount of memory, add-in cards, peripherals, etc.) may exceed the minimum power requirement. To ensure that adequate power is provided, we strongly recommend that you use a minimum of 400 Watt (or greater) power supply.



Important:

Insufficient power supplied to the system may result in instability or the add-in boards and peripherals not functioning properly. Calculating the system's approximate power usage is important to ensure that the power supply meets the system's consumption requirements.

Expansion Slots

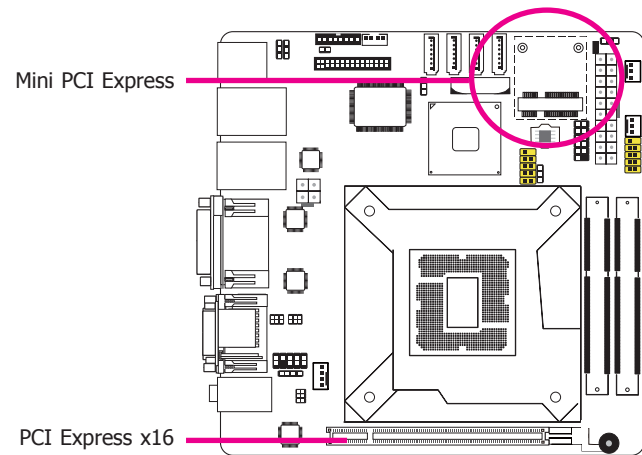

PCI Express x16 Slot

The PCI Express x16 slot is an interface for the X100-3PE2 riser card. The X100-3PE2 features:

- 1 PCIe x1 slot
- 1 PCI slot
- 1 Mini PCIe slot

Mini PCI Express Slot

The Mini PCI Express slot on the system board is used to install a half size Mini PCIe card such as network cards or other cards that comply to the mini PCI Express specifications into the mini PCI Express slot.



Note:

The Mini PCIe slot on the system board and on the X100-3PE2 riser card can be used at the same time.

Front Panel Connectors

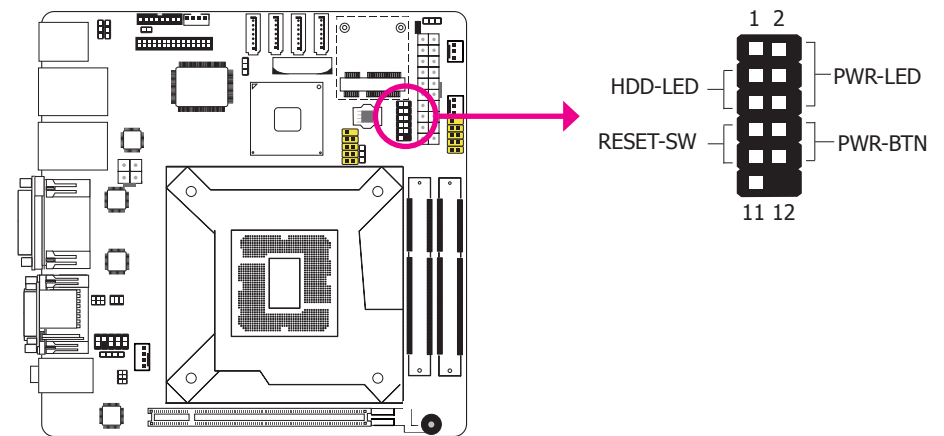

HDD-LED - HDD LED

This LED will light when the hard drive is being accessed.

RESET SW - Reset Switch

This switch allows you to reboot without having to power off the system.

PWR-BTN - Power Switch

This switch is used to power on or off the system.

PWR-LED - Power/Standby LED

When the system's power is on, this LED will light. When the system is in the S1 (POS - Power On Suspend) state, it will blink every second. When the system is in the S3 (STR - Suspend To RAM) state, it will blink every 4 seconds.

	Pin	Pin Assignment		Pin	Pin Assignment
HDD-LED	3	HDD Power	PWR-LED	2	LED Power
	5	Signal		4	LED Power
RESET SW	7	Ground	PWR-BTN	6	Signal
	9	RST Signal		8	Ground
	11	N.C.		10	Signal

Battery

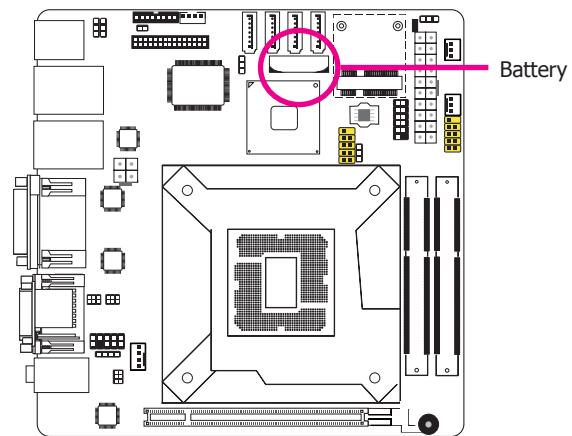

The lithium ion battery powers the real-time clock and CMOS memory. It is an auxiliary source of power when the main power is shut off.

Safety Measures

- Danger of explosion if battery incorrectly replaced.
- Replace only with the same or equivalent type recommend by the manufacturer.
- Dispose of used batteries according to local ordinance.

SDVO Connector

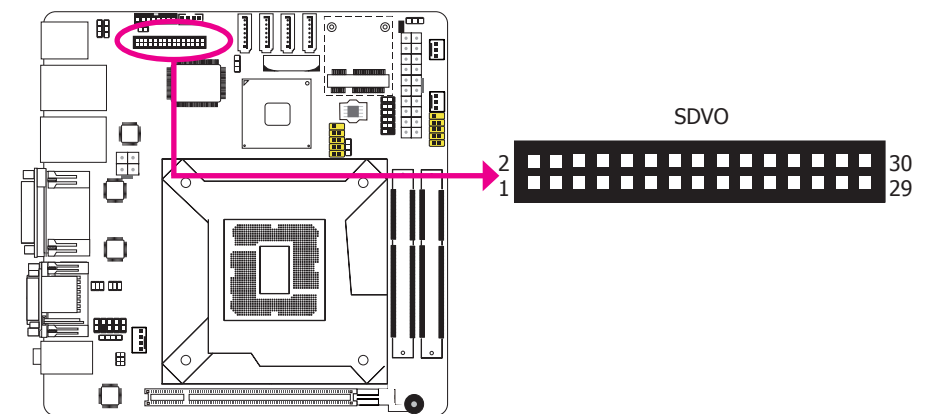

The SDVO connector is used to connect the optional SDVO-LVDS daughterboard.

Pins	Pin Assignment	Pins	Pin Assignment
1	Ground	2	DPB_AUXP
3	DPB_LANE0_P	4	DPB_AUXN
5	DPB_LANE0_N	6	SDVO_STALLP
7	Ground	8	SDVO_STALLN
9	DPB_LANE1_P	10	SDVO_INTP
11	DPB_LANE1_N	12	SDVO_INTN
13	Ground	14	PCIE_RST
15	DPB_LANE2_P	16	DPB_CTRLCLK
17	DPB_LANE2_N	18	DPB_CTRLDATA
19	Ground	20	DPB_HPD
21	DPB_LANE3_P	22	GPIO15/SMBCLK
23	DPB_LANE3_N	24	GPIO27/SMBDATA/L_BKLTCTL
25	+3V3	26	+3V3
27	+5V	28	+5V
29	+12V	30	+12V

SDVO-LVDS Daughterboard (optional)

Features

- Chronitel CH7308B
- Supports 18/24-bit 1600x1200 LVDS panel (default 1280x1024)
- 1 LVDS LCD panel connector
- 1 LCD/Inverter power connector
- SDVO interface
- Supports dimming control via hot keys or AP tool

Dimensions

- 45mm (1.77") x 38mm (1.49")

Power Select for the LCD Panel

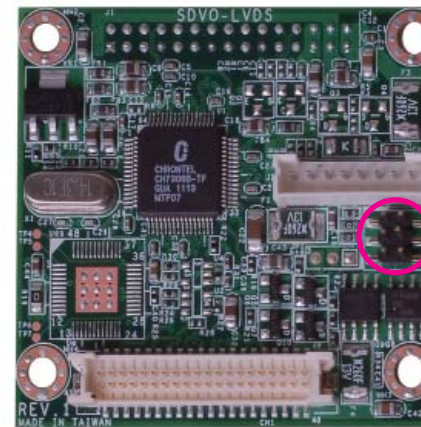

1 2
3 4
5 6
1-2 On: +12V

1 2
3 4
5 6
3-4 On: +5V

1 2
3 4
5 6
5-6 On: +3.3V
(default)

JP8 is used to select the power supplied to the LCD panel.



Important:

Before powering-on the system, make sure JP8's setting matches the LCD panel's specification. Selecting the incorrect voltage will seriously damage the LCD panel.

LVDS LCD Panel and LCD Inverter Power Connectors

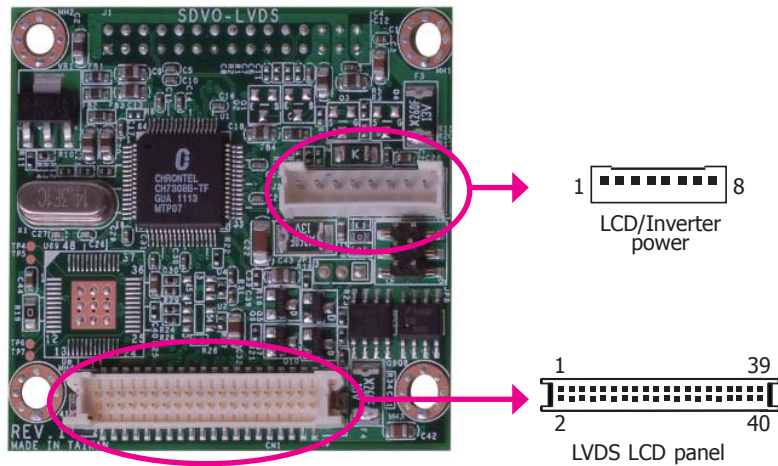

The system board allows you to connect a LCD Display Panel by means of the LVDS LCD panel connector and the LCD/Inverter power connector. These connectors transmit video signals and power from the system board to the LCD Display Panel.

LVDS LCD Panel Connector

Pins	Function	Pins	Function
1	GND	2	GND
3	LVDS_Out3+	4	LVDS_Out7+
5	LVDS_Out3-	6	LVDS_Out7-
7	GND	8	GND
9	LVDS_Out2+	10	LVDS_Out6+
11	LVDS_Out2-	12	LVDS_Out6-
13	GND	14	GND
15	LVDS_Out1+	16	LVDS_Out5+
17	LVDS_Out1-	18	LVDS_Out5-
19	GND	20	GND
21	LVDS_Out0+	22	LVDS_Out4+
23	LVDS_Out0-	24	LVDS_Out4-
25	GND	26	GND
27	LVDS_CLK1+	28	LVDS_CLK2+
29	LVDS_CLK1-	30	LVDS_CLK2-
31	GND	32	GND
33	LVDS_DDCCLK	34	N.C.
35	LVDS_DDCDAA	36	N.C.
37	Panel Power	38	Panel Power
39	Panel Power	40	Panel Power

LCD/Inverter Power Connector

Pins	Function
1	GND
2	GND
3	Panel Inverter Brightness Voltage Control
4	Panel Power
5	+3.3V
6	Panel Backlight On/Off Control
7	+12V
8	+12V

Installing the SDVO-LVDS Daughterboard onto the Motherboard (optional)

**Important:**

The motherboard used in this section is for reference purpose only and may not resemble your motherboard. These illustrations are mainly to guide you on how to install SDVO-LVDS onto the motherboard of your choice.

1. The photo below shows the location of the mounting hole on the motherboard.

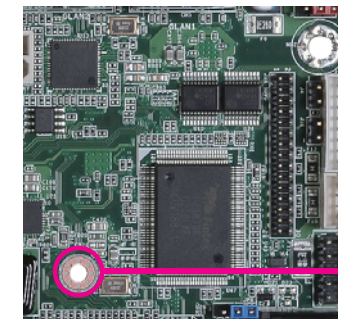

Mounting hole

2. Insert the provided mounting screw into the mounting hole - from the bottom through the top of the motherboard.

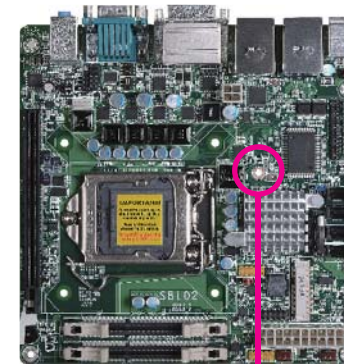

Mounting hole

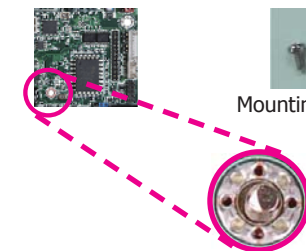

Mounting screw

3. While supporting the mounting screw at the bottom, from the top side of the board, fasten a bolt into the screw.

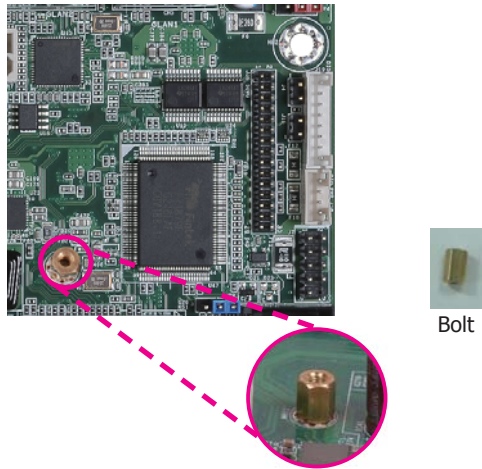

Bolt

4. The SDVO connector is located at the bottom of the daughterboard. Grasping the daughterboard by its edges, position it on top of the motherboard's SDVO connector with its mounting holes aligned with the bolt on the motherboard. This will also align the SDVO connector of the two boards to each other.



SDVO connector at the bottom side of the daughterboard

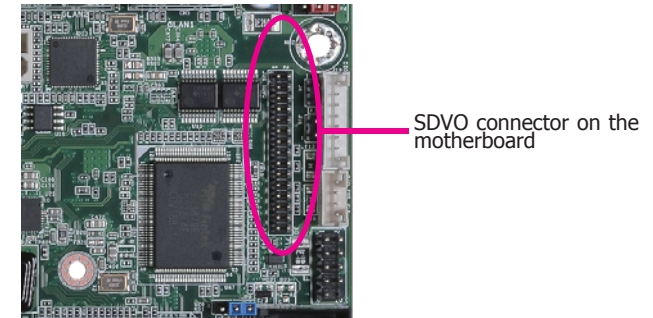

SDVO connector on the motherboard

5. Press the daughterboard down firmly until it is completely seated on the SDVO connector of the motherboard.

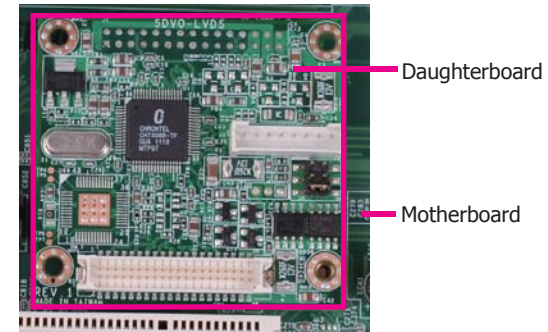

Daughterboard

Motherboard

6. Use the provided mounting screw to secure the daughterboard to the motherboard.

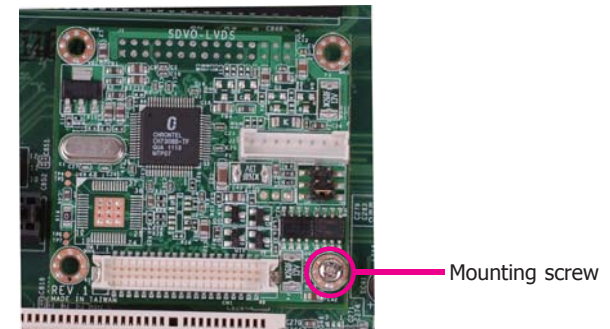

Mounting screw

Chapter 6 - Mounting Options

Wall Mount

The wall mount kit includes the following:

- 2 Wall mount brackets
- Bracket screws

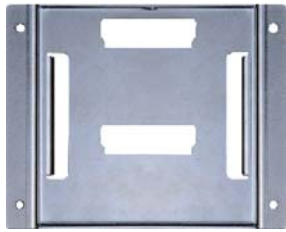

Wall mount bracket 1



Wall mount bracket 2

1. Select a place on the wall where you will mount the Panel PC.
2. Use the provided mounting screws to attach "wall mount bracket 1" to the wall.

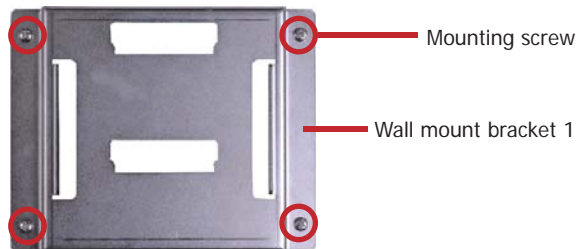

3. Attach the other bracket (wall mount bracket 2) to the rear of the Panel PC.

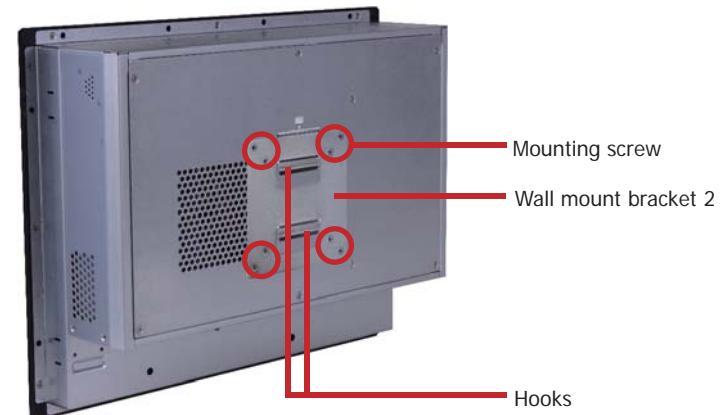

4. Using the hooks on "bracket 2", slide the Panel PC to "bracket 1".

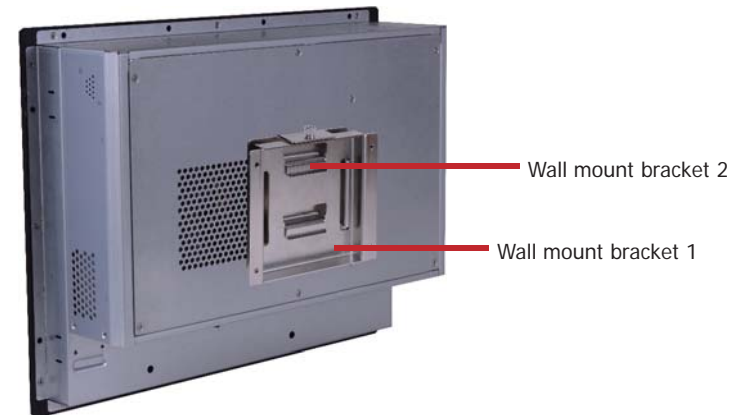

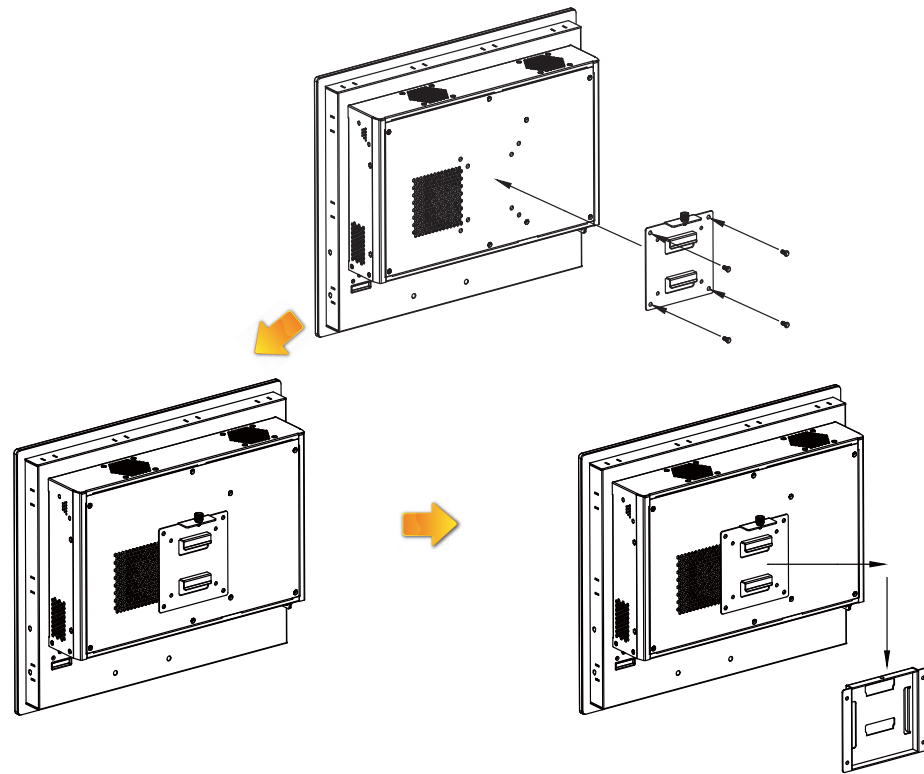

Panel Mount

- The panel mounting kit includes the following:
- 10 mounting clamps (TPC121 and TPC150)
 - 12 mounting clamps (TPC170)



1. Select a place on the panel where you will mount the Panel PC.
2. Cut out a shape on the panel that corresponds to the Panel PC's rear dimensions.

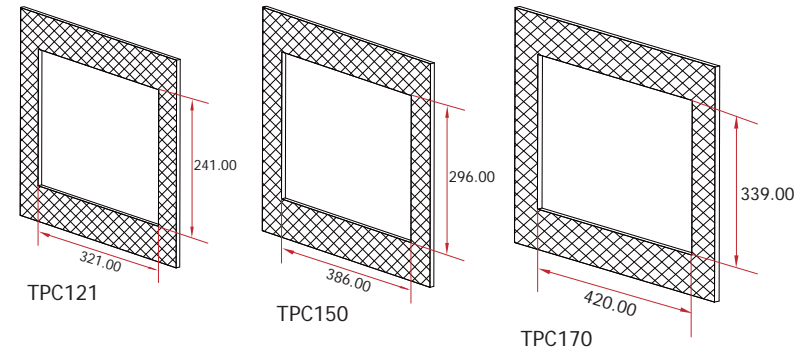

3. Stick the poron foam on the rear panel.

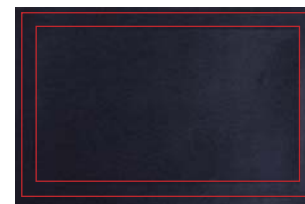

Poron foam



Poron foam

4. Slide the Panel PC through the hole until it is properly fitted against the panel.
5. Position the mounting clamps along the rear edges of the Panel PC, fitting them into the slits that are around the Panel PC.



6. The first and second clamps must be positioned and secured diagonally prior to mounting the rest of the clamps. Tighten the clamp's screw using an electric screwdriver until the white plastic cap touches the panel. Do not over tighten the screws to prevent damaging the Panel PC. The illustration below shows all clamps properly mounted.

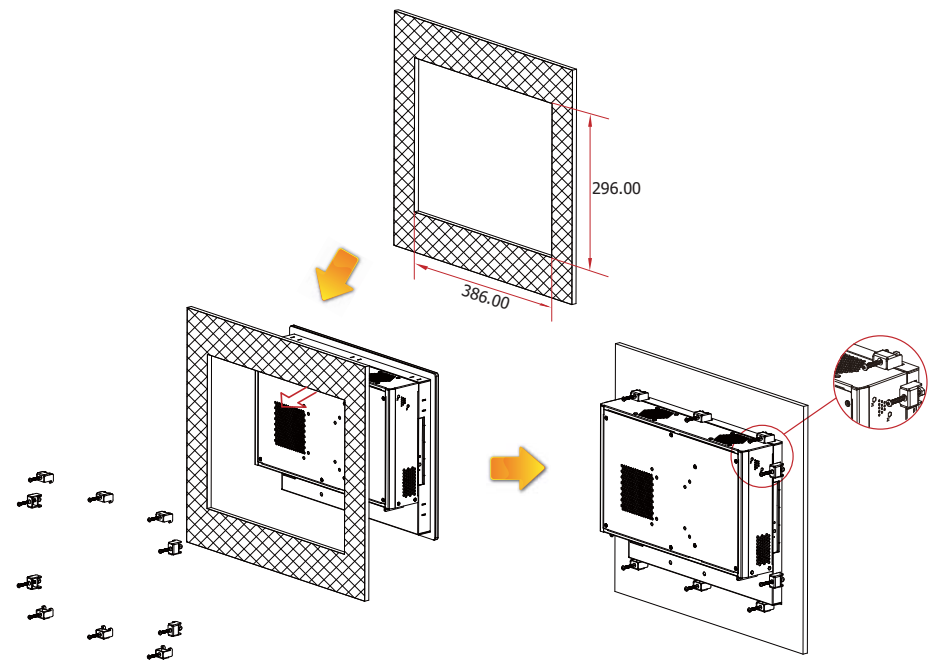

Chapter 7 - BIOS Setup

Overview

The BIOS is a program that takes care of the basic level of communication between the CPU and peripherals. It contains codes for various advanced features found in this system board. The BIOS allows you to configure the system and save the configuration in a battery-backed CMOS so that the data retains even when the power is off. In general, the information stored in the CMOS RAM of the EEPROM will stay unchanged unless a configuration change has been made such as a hard drive replaced or a device added.

It is possible that the CMOS battery will fail causing CMOS data loss. If this happens, you need to install a new CMOS battery and reconfigure the BIOS settings.



Note:

The BIOS is constantly updated to improve the performance of the system board; therefore the BIOS screens in this chapter may not appear the same as the actual one. These screens are for reference purpose only.

Default Configuration

Most of the configuration settings are either predefined according to the Load Optimal Defaults settings which are stored in the BIOS or are automatically detected and configured without requiring any actions. There are a few settings that you may need to change depending on your system configuration.

Entering the BIOS Setup Utility

The BIOS Setup Utility can only be operated from the keyboard and all commands are keyboard commands. The commands are available at the right side of each setup screen.

The BIOS Setup Utility does not require an operating system to run. After you power up the system, the BIOS message appears on the screen and the memory count begins. After the memory test, the message "Press DEL to run setup" will appear on the screen. If the message disappears before you respond, restart the system or press the "Reset" button. You may also restart the system by pressing the <Ctrl> <Alt> and keys simultaneously.

Legends

Keys	Function
Right and Left arrows	Moves the highlight left or right to select a menu.
Up and Down arrows	Moves the highlight up or down between submenu or fields.
<Esc>	Exit to the BIOS Setup Utility.
+ (plus key)	Scrolls forward through the values or options of the highlighted field.
- (minus key)	Scrolls backward through the values or options of the highlighted field.
Tab	Select a field.
<F1>	Displays General Help
<F4>	Saves and exits the Setup program.
<Enter>	Press <Enter> to enter the highlighted submenu.

Scroll Bar

When a scroll bar appears to the right of the setup screen, it indicates that there are more available fields not shown on the screen. Use the up and down arrow keys to scroll through all the available fields.

Submenu

When "►" appears on the left of a particular field, it indicates that a submenu which contains additional options are available for that field. To display the submenu, move the highlight to that field and press <Enter>.

AMI BIOS Setup Utility

Main

The Main menu is the first screen that you will see when you enter the BIOS Setup Utility.

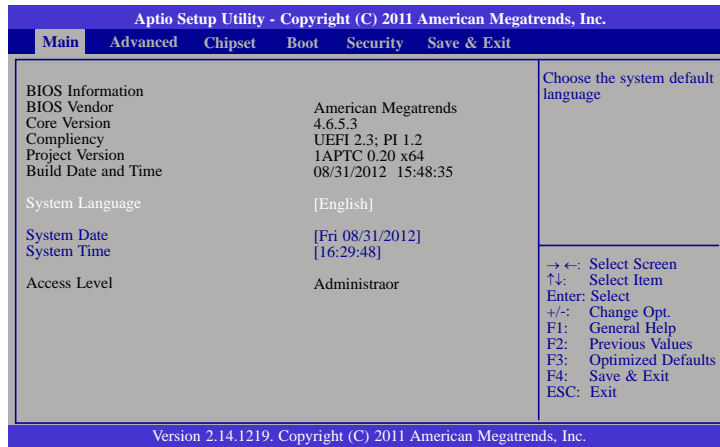

System Date

The date format is <day>, <month>, <date>, <year>. Day displays a day, from Sunday to Saturday. Month displays the month, from January to December. Date displays the date, from 1 to 31. Year displays the year, from 1980 to 2099.

System Time

The time format is <hour>, <minute>, <second>. The time is based on the 24-hour military-time clock. For example, 1 p.m. is 13:00:00. Hour displays hours from 00 to 23. Minute displays minutes from 00 to 59. Second displays seconds from 00 to 59.

Advanced

The Advanced menu allows you to configure your system for basic operation. Some entries are defaults required by the system board, while others, if enabled, will improve the performance of your system or let you set some features according to your preference.



Important:

Setting incorrect field values may cause the system to malfunction.

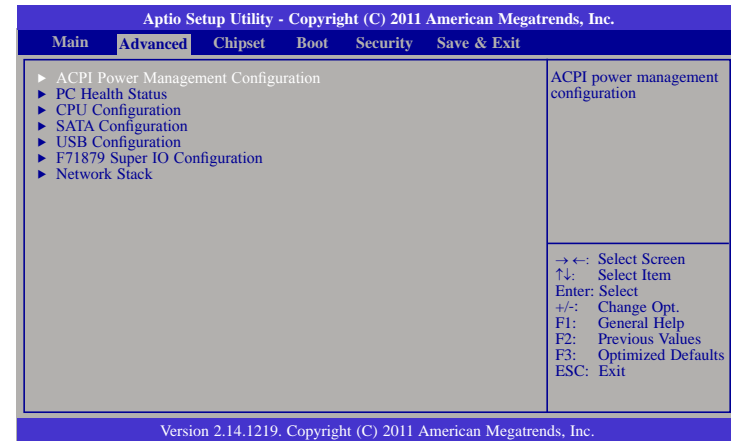

ACPI Power Management Configuration

This section is used to configure the ACPI Power Management.

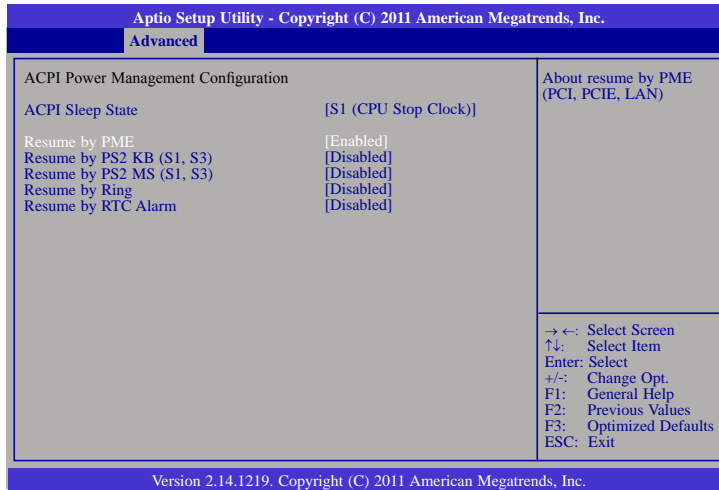

ACPI Sleep State

Selects the highest ACPI sleep state the system will enter when the Suspend button is pressed.

S1(POS) Enables the Power On Suspend function.

S3(STR) Enables the Suspend to RAM function.

Resume by PME

Enable this field to use the PME signal to wake up the system.

Resume by PS2 KB (S1, S3)

About resume by PS2 KB (S1, S3); Options are enabled or disabled.

Resume by PS2 MS (S1, S3)

About resume by PS2 MS (S1, S3); Options are enabled or disabled.

Resume by Ring

Enable this field to use the Ring signal to wake up the system.

Resume by RTC Alarm

When Enabled, the system uses the RTC to generate a wakeup event.

PC Health Status

This section displays the SIO hardware health monitor.

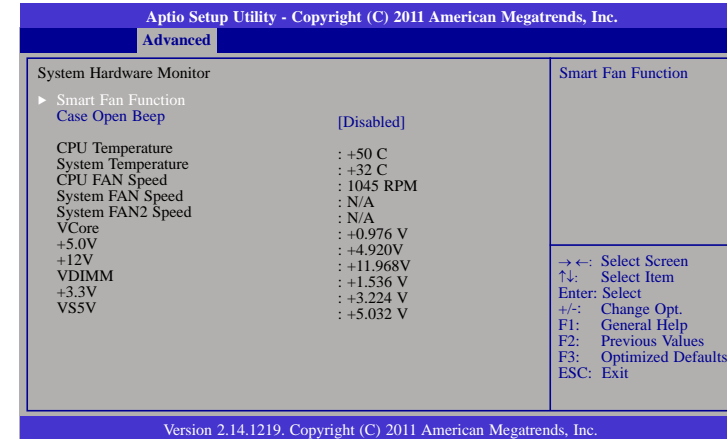

Smart Fan Function

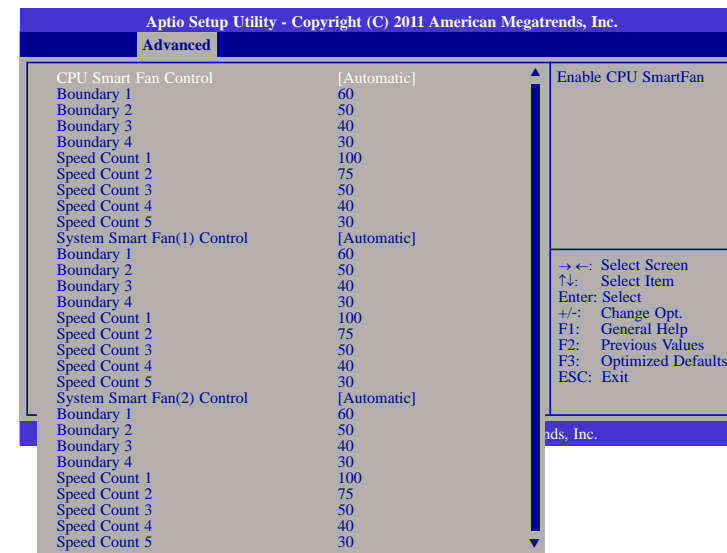

CPU Smart Fan Control

When this feature is set to Automatic, the CPU's fan speed will rotate according to the CPU's temperature. The higher the temperature, the faster the speed of rotation.

Boundary 1 to Boundary 4

The range is from 0-127.

Speed Count 1 to Speed Count 5

The range is from 1-100.

Case Open Beep

Set this field to Enabled to allow the system to alert you of a chassis intrusion event.

CPU Configuration

This section is used to configure the CPU. It will also display the detected CPU information.

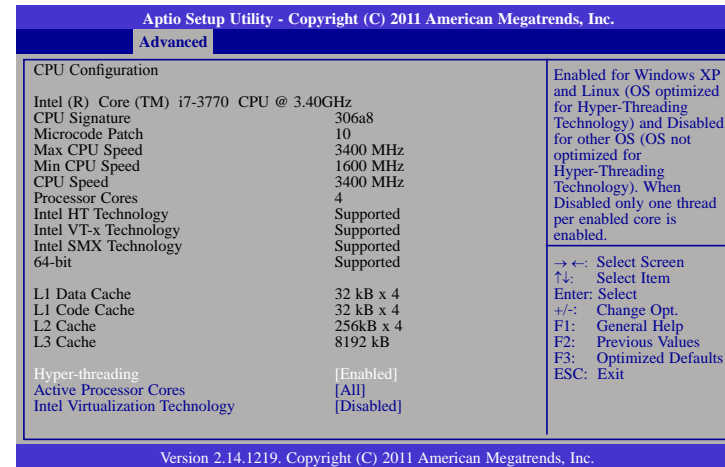

Hyper-threading

Enable this field for Windows XP and Linux which are optimized for Hyper-Threading technology. Select disabled for other OSes not optimized for Hyper-Threading technology. When disabled, only one thread per enabled core is enabled.

Active Processor Cores

Number of cores to enable in each processor package.

Intel Virtualization Technology

When this field is set to Enabled, the VMM can utilize the additional hardware capabilities provided by Vanderpool Technology.

SATA Configuration

This section is used to configure SATA functions.

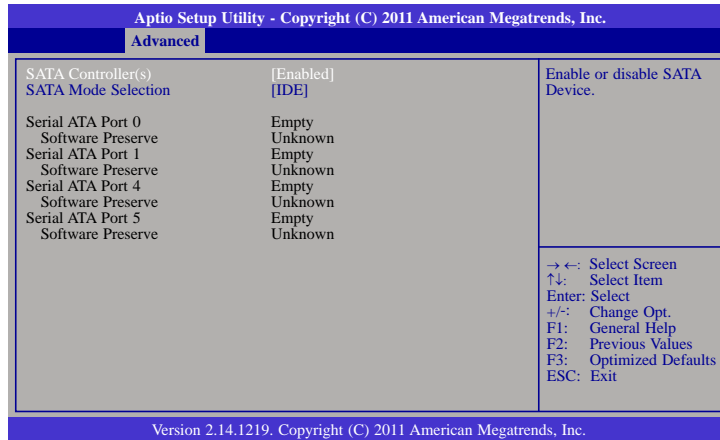

SATA Controller(s)

This field is used to enable or disable the Serial ATA channels.

SATA Mode Selection

IDE Mode

This option configures the Serial ATA drives as Parallel ATA storage devices.

USB Configuration

This section is used to configure USB.

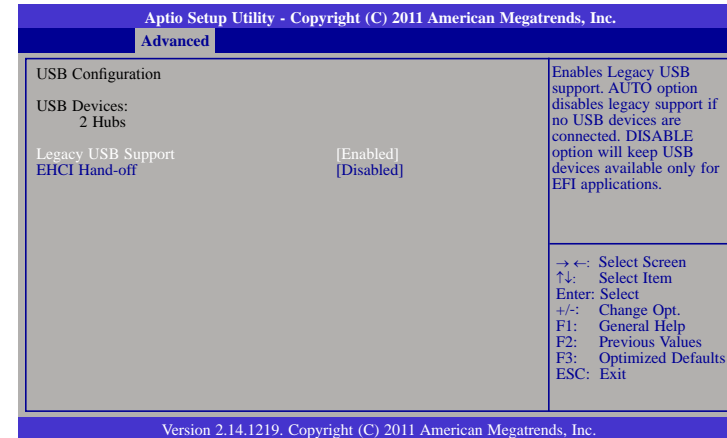

Legacy USB Support

Enabled

Enables legacy USB.

Auto

Disables support for legacy when no USB devices are connected.

Disabled

Keeps USB devices available only for EFI applications.

EHCI Hand-off

This is a workaround for OSeS that does not support EHCI hand-off. The EHCI ownership change should be claimed by the EHCI driver.

F71879 Super IO Configuration

This section is used to configure the I/O functions supported by the onboard Super I/O chip.

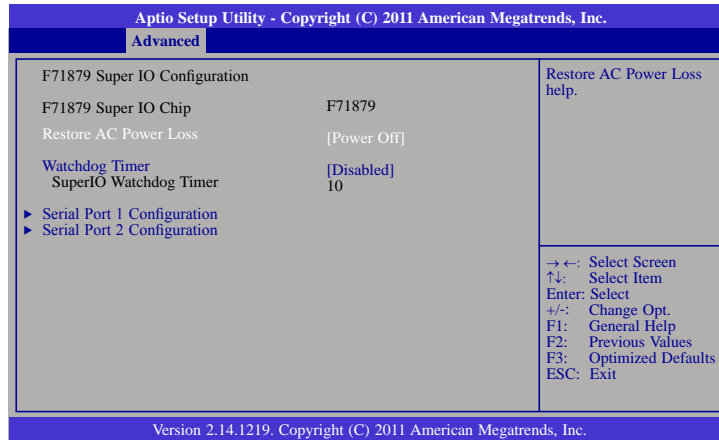

Restore AC Power Loss

Off

When power returns after an AC power failure, the system's power is off. You must press the Power button to power-on the system.

On

When power returns after an AC power failure, the system will automatically power-on.

Last State

When power returns after an AC power failure, the system will return to the state where you left off before power failure occurs. If the system's power is off when AC power failure occurs, it will remain off when power returns. If the system's power is on when AC power failure occurs, the system will power-on when power returns.

Watchdog Timer

Enable or disable Super I/O watchdog timer.

Serial Port 1 Configuration to Serial Port 2 Configuration

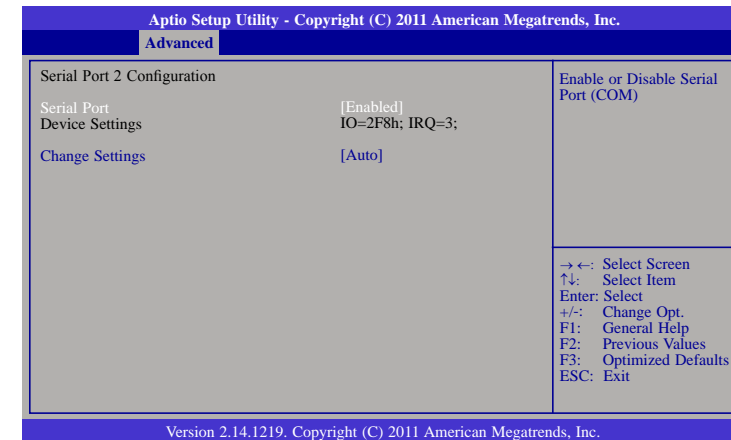
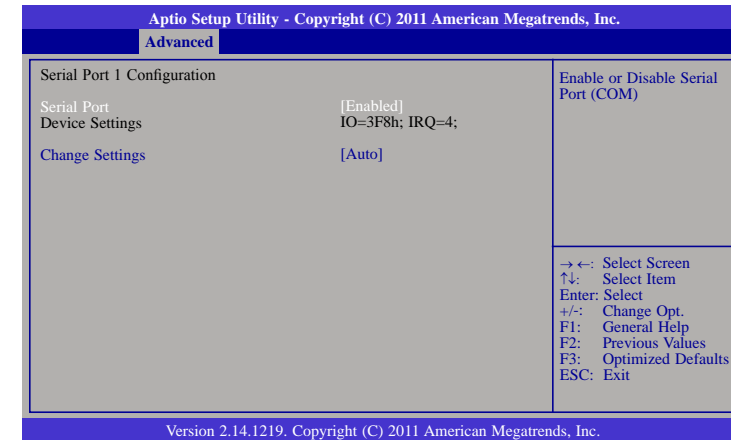

Serial Port

Enables or disables the serial port.

Change Settings

Selects the IO/IRQ setting of the I/O device.

Network Stack

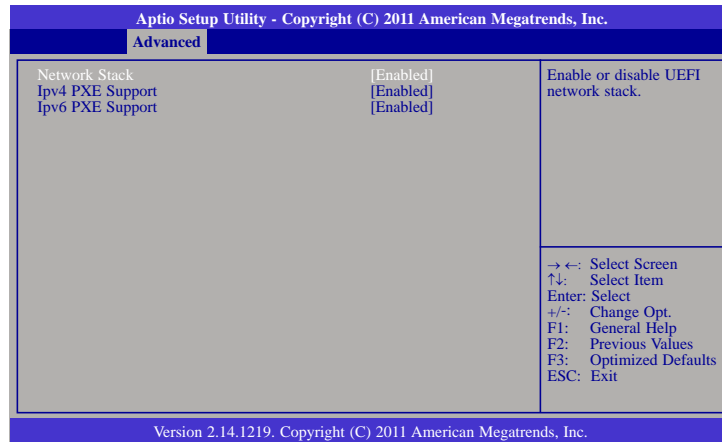

Ipv4 PXE Support

Enable Ipv4 PXE Boot Support. If disabled Ipv4 PXE boot option will not be created.

Ipv6 PXE Support

Enable Ipv6 PXE Boot Support. If disabled Ipv6 PXE boot option will not be created.

Chipset

Configures relevant chipset functions.

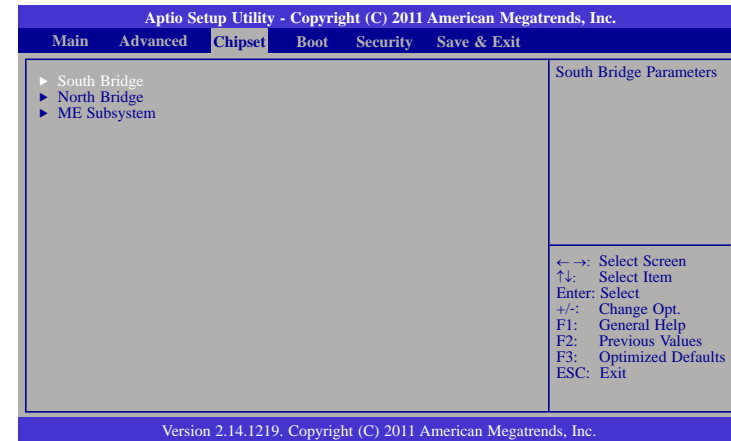

South Bridge

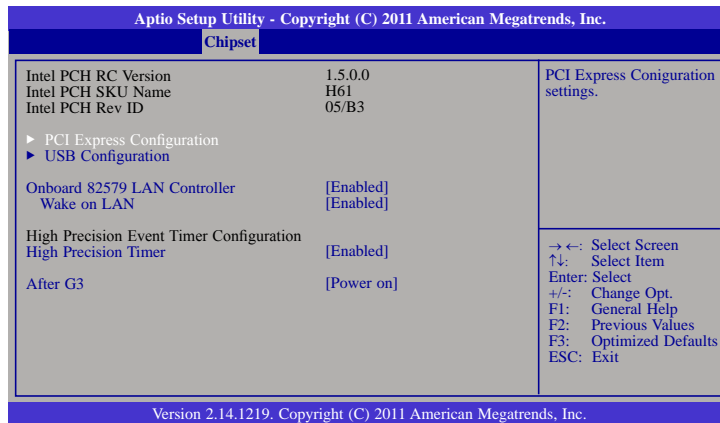

Onboard LAN 82579 LAN Controller

Enabled or disable LAN.

Wake on LAN

Enable or disable integrated LAN to wake the system. (The Wake on LAN cannot be disabled if ME is on at Sx state.)

High Precision Timer

Enable or disable the High Precision Timer.

After G3

Power Off / WOL

Power-on the system via WOL after G3.

Power On

Power-on the system after G3.

PCI Express Configuration

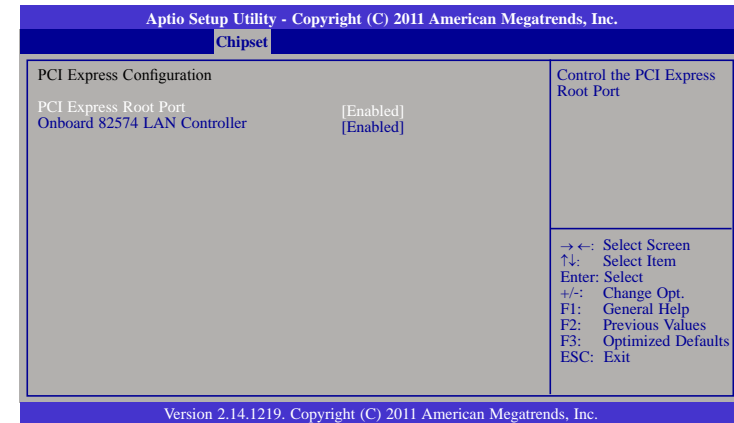

Onboard 82574 LAN Controller

Enables or disables onboard 82574 LAN controller.

USB Configuration

Aptio Setup Utility - Copyright (C) 2011 American Megatrends, Inc.		
Chipset		
USB Configuration		Control the USB EHCI (USB 2.0) functions. One EHCI controller must always be enabled.
EHCI1	[Enabled]	
EHCI2	[Enabled]	
USB Ports Per-Port Disable Controller	[Disabled]	
		→ ←: Select Screen ↑↓: Select Item Enter: Select +/-: Change Opt. F1: General Help F2: Previous Values F3: Optimized Defaults ESC: Exit
Version 2.14.1219. Copyright (C) 2011 American Megatrends, Inc.		

EHCI1 and EHCI2

These fields are used to enable or disable USB 2.0.

USB Ports Per-Port Disable Controller

Control each of the USB ports (0~13) disabling.

North Bridge

Aptio Setup Utility - Copyright (C) 2011 American Megatrends, Inc.		
Chipset		
System Agent Bridge Name	IvyBridge	Check to enable VT-d function on MCH.
System Agent RC Version	1.5.0.0	
VT-d Capability	Supported	
VT-d		
▶ Graphics Configuration		
▶ NB PCIe Configuration		
▶ Memory Configuration		
		→ ←: Select Screen ↑↓: Select Item Enter: Select +/-: Change Opt. F1: General Help F2: Previous Values F3: Optimized Defaults ESC: Exit
Version 2.14.1219. Copyright (C) 2011 American Megatrends, Inc.		

Graphics Configuration

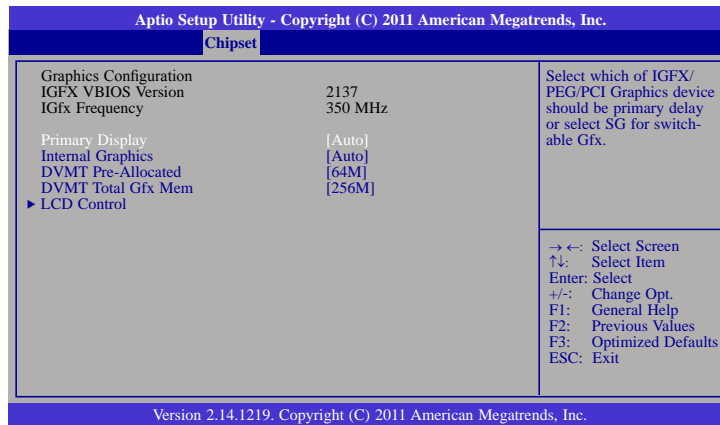

Primary Display

- Auto When the system boots, it will auto detects the display device.
- IGFX When the system boots, it will first initialize the onboard VGA.
- PEG When the system boots, it will first initialize the PCI Express x16 graphics card.

Internal Graphics

Keep IGD enabled based on the setup options.

DVMT Pre-Allocated

Select DVMT 5.0 Pre-Allocated (Fixed) Graphics Memory size used by the Internal Graphics Device.

DVMT Total Gfx Mem

This field is used to select the graphics memory size used by DVMT mode.

LCD Control

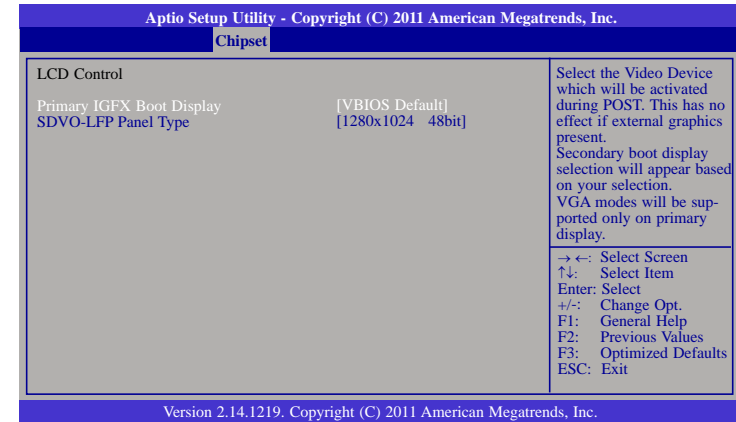

Primary IGFX Boot Display

The options are VBIOS Default, CRT, EFP2, LFP, EFP.

SDVO-LFP Panel Type

Select SDVO panel used by the internal graphics device by selecting the appropriate setup item.



Note:
EFP2 means HDMI, LFP means LVDS and EFP means DVI.

NB PCIe Configuration

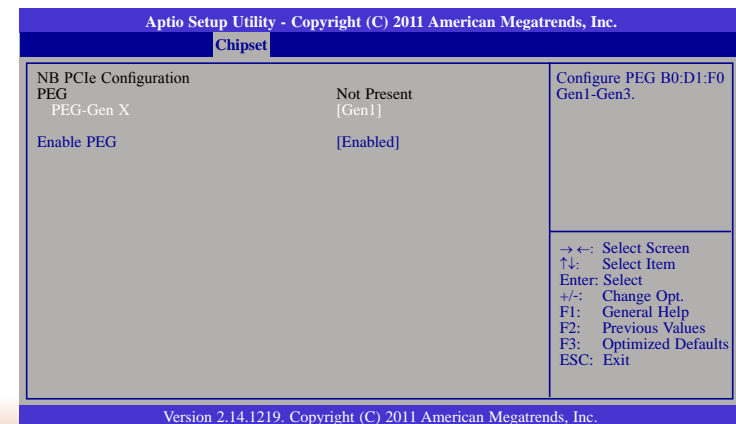

CSM Parameters

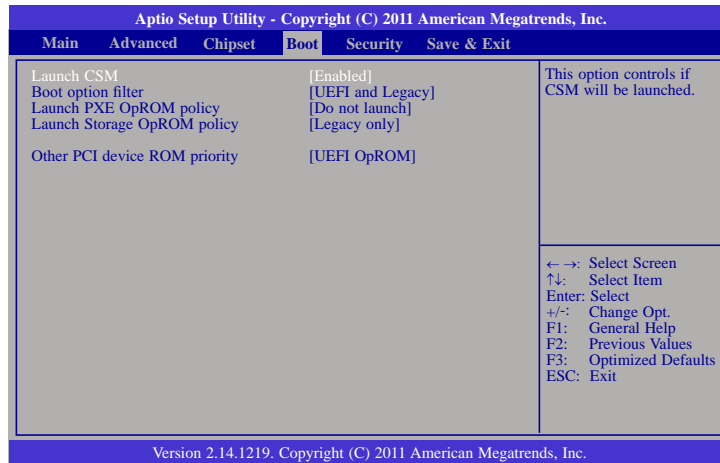

Boot option filter

This option controls what devices system can be boot to.

Launch PXE OpROM policy

Controls the execution of UEFI and legacy PXE OpROM.

Launch Storage OpROM policy

Controls the execution of UEFI and legacy storage OpROM.

Other PCI device ROM priority

For PCI devices other than Network, Mass Storage, or Video defines which OpROM to launch.

Security

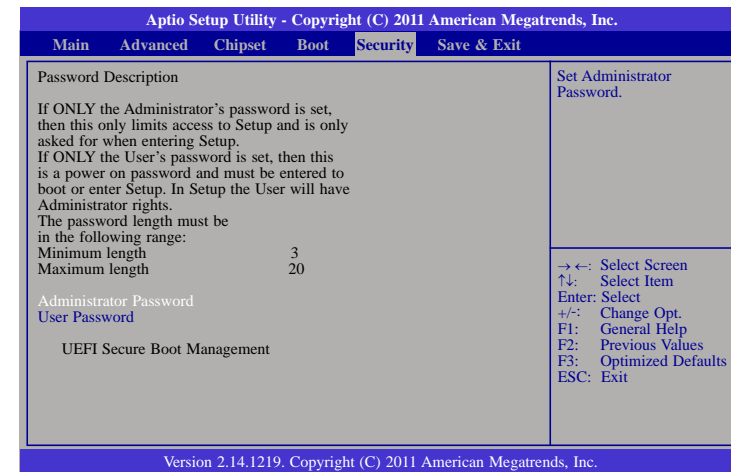

Administrator Password

Sets the administrator password.

User Password

Sets the user password.

Save & Exit

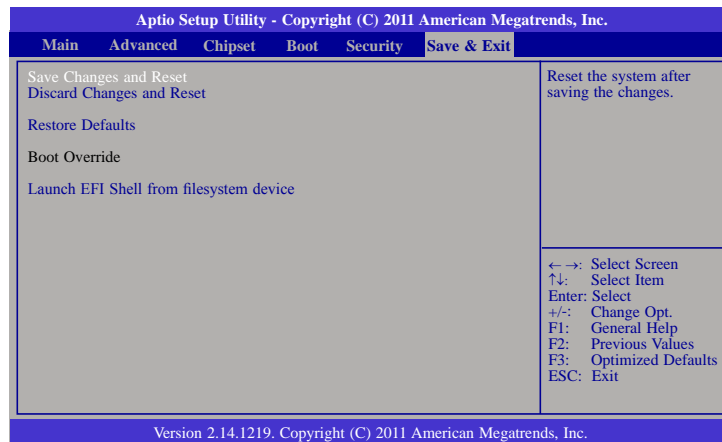

Save Changes and Reset

To save the changes, select this field and then press <Enter>. A dialog box will appear. Select Yes to reset the system after saving all changes made.

Discard Changes and Reset

To discard the changes, select this field and then press <Enter>. A dialog box will appear. Select Yes to reset the system setup without saving any changes.

Restore Defaults

To restore and load the optimized default values, select this field and then press <Enter>. A dialog box will appear. Select Yes to restore the default values of all the setup options.

Launch EFI Shell from filesystem device

Attempts to Launch EFI Shell application (Shellx64.efi) from one of the available filesystem devices.

Updating the BIOS

To update the BIOS, you will need the new BIOS file and a flash utility, AFUDOS.EXE. Please contact technical support or your sales representative for the files.

To execute the utility, type:

```
A:> AFUDOS BIOS_File_Name /b /p /n
```

then press <Enter>.

```
C:\AFU\AFUDOS>afudos filename /B /P /N
-----+-----
                AMI Firmware Update Utility(APTIO) v2.25
                Copyright (C)2008 American Megatrends Inc. All Rights Reserved.
-----+-----
Reading file ..... done
Erasing flash ..... done
Writing flash ..... done
Verifying flash ..... done
Erasing BootBlock ..... done
Writing BootBlock ..... done
Verifying BootBlock ..... done

C:\AFU\AFUDOS>
```

Chapter 8 - Supported Software

The CD that came with the system board contains drivers, utilities and software applications required to enhance the performance of the system board.

Insert the CD into a CD-ROM drive. The autorun screen (Mainboard Utility CD) will appear. If after inserting the CD, "Autorun" did not automatically start (which is, the Mainboard Utility CD screen did not appear), please go directly to the root directory of the CD and double-click "Setup".

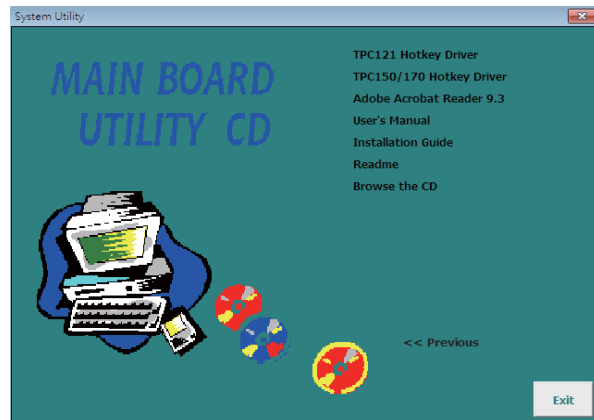
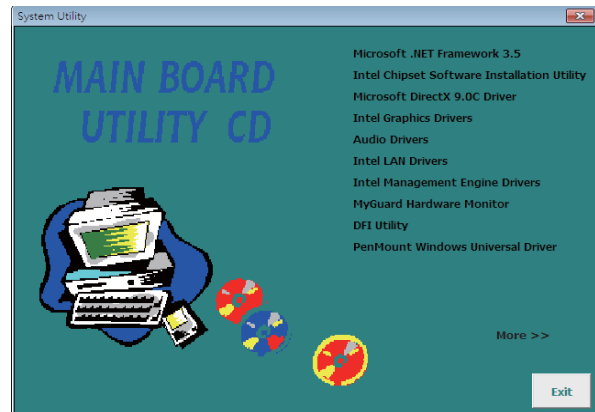

Auto Run Pages (for Windows 7)

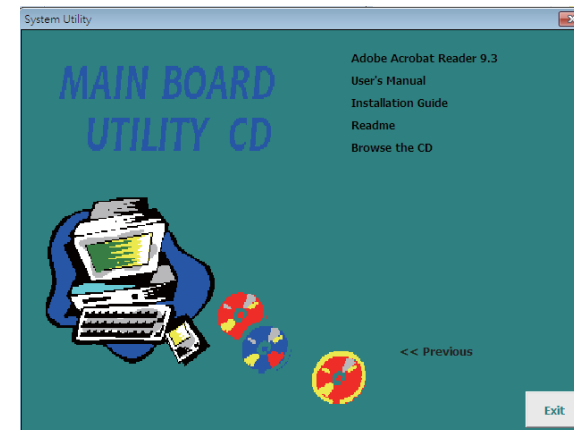
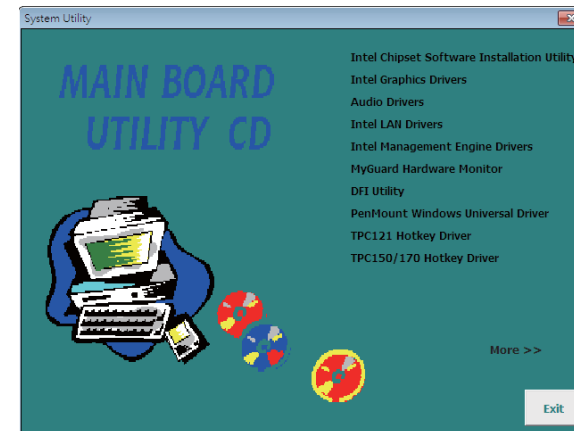

Microsoft .NET Framework 3.5 (for Windows XP only)



Note:

Before installing Microsoft .NET Framework 3.5, make sure you have updated your Windows XP operating system to Service Pack 3.

To install the driver, click “Microsoft .NET Framework 3.5” on the main menu.

1. Read the license agreement carefully.

Click “I have read and accept the terms of the License Agreement” then click Install.

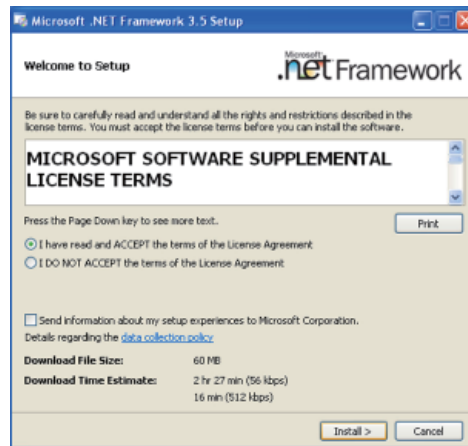

2. Setup is now installing the driver.

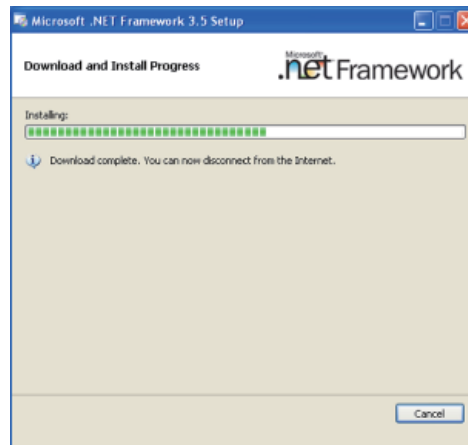

3. Click Exit.

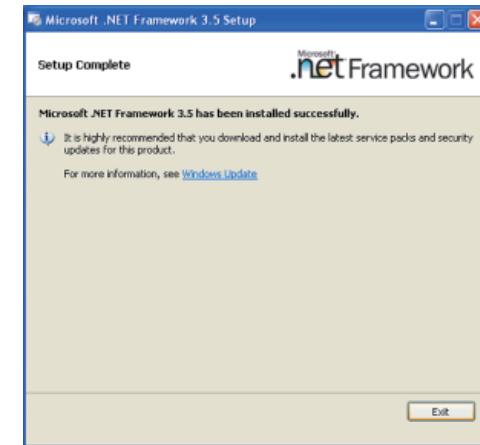

Intel Chipset Software Installation Utility

The Intel Chipset Software Installation Utility is used for updating Windows® INF files so that the Intel chipset can be recognized and configured properly in the system.

To install the utility, click “Intel Chipset Software Installation Utility” on the main menu.

1. Setup is ready to install the utility. Click Next.



2. Read the license agreement then click Yes.



3. Go through the readme document for more installation tips then click Next.



4. Click Finish to exit setup.



Microsoft DirectX 9.0C (for Windows XP only)

To install the driver, click “Microsoft DirectX 9.0C” on the main menu.

1. Click “I accept the agreement” then click Next.

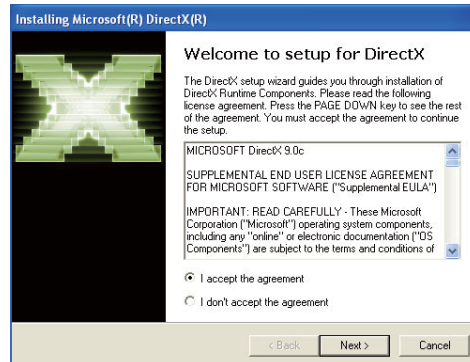

2. To start installation, click Next.

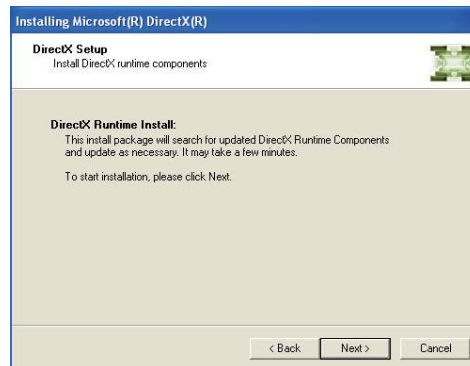

3. Click Finish. Reboot the system for DirectX to take effect.

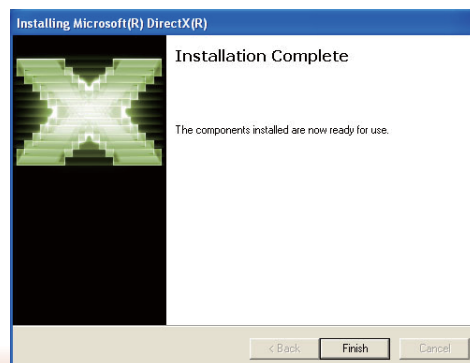

Intel Graphics Drivers

To install the driver, click “Intel Graphics Drivers” on the main menu.

1. Setup is now ready to install the graphics driver. Click Next.

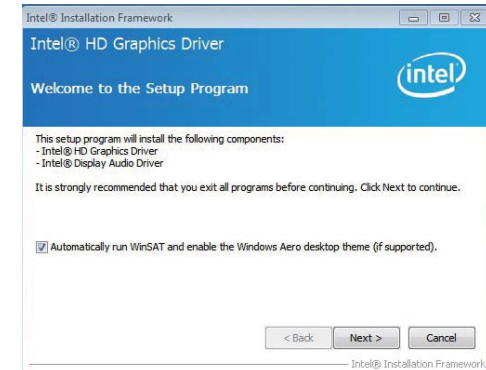

By default, the “Automatically run WinSAT and enable the Windows Aero desktop theme” is enabled. With this enabled, after installing the graphics driver and the system rebooted, the screen will turn blank for 1 to 2 minutes (while WinSAT is running) before the Windows Vista desktop appears. The “blank screen” period is the time Windows is testing the graphics performance.

2. Read the license agreement then click Yes.

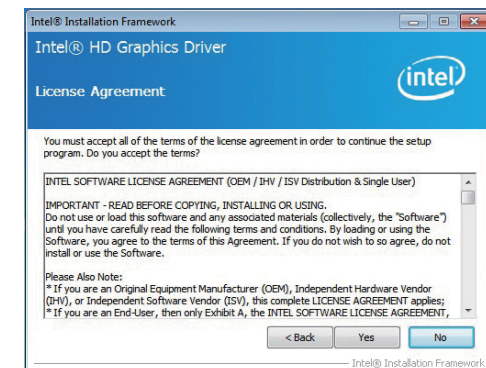

- Go through the readme document for system requirements and installation tips then click Next.

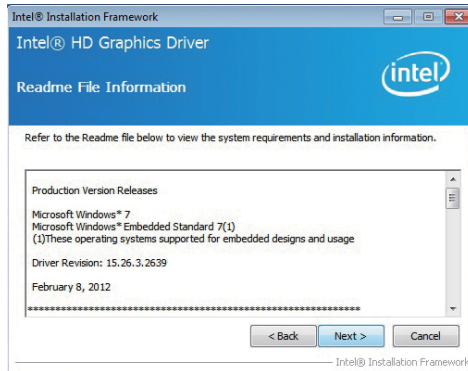

- Setup is now installing the driver. Click Next to continue.

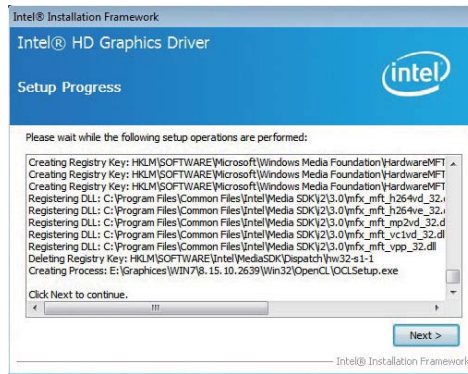

- Click "Yes, I want to restart this computer now" then click Finish.

Restarting the system will allow the new software installation to take effect.

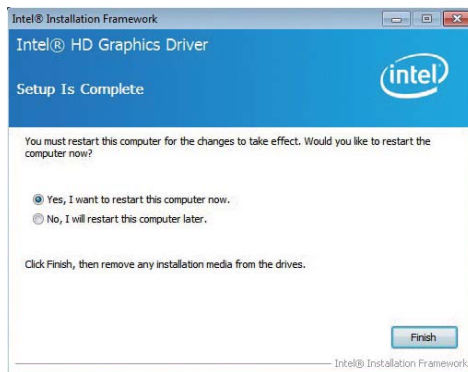

Audio Drivers

To install the driver, click "Audio Drivers" on the main menu.

- Setup is ready to install the driver. Click Next.

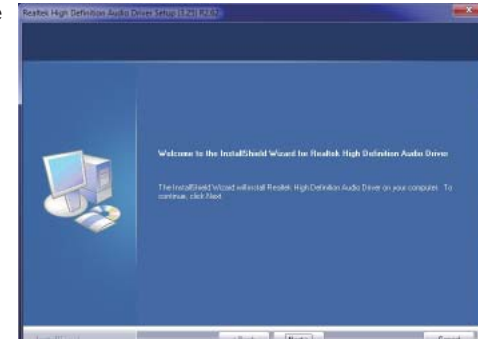

- Click "Yes, I want to restart my computer now" then click Finish.

Restarting the system will allow the new software installation to take effect.

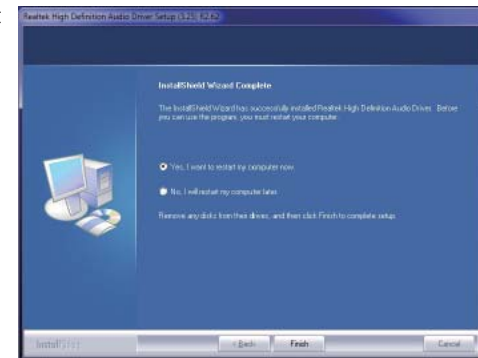

Intel LAN Drivers

To install the driver, click "Intel LAN Drivers" on the main menu.

1. Setup is ready to install the driver. Click Next.



2. Click "I accept the terms in the license agreement" then click "Next".

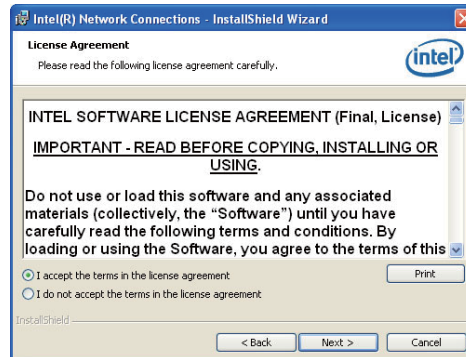

3. Select the program features you want installed then click Next.

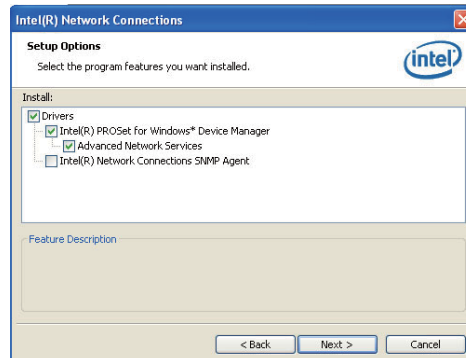

4. Click Install to begin the installation.

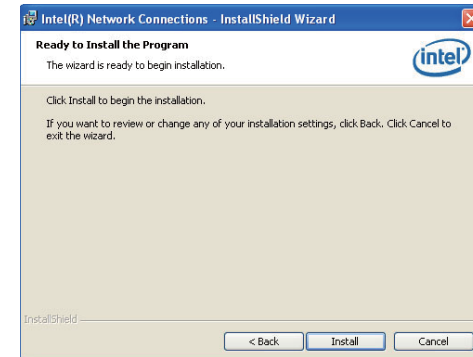

5. After completing installation, click Finish.

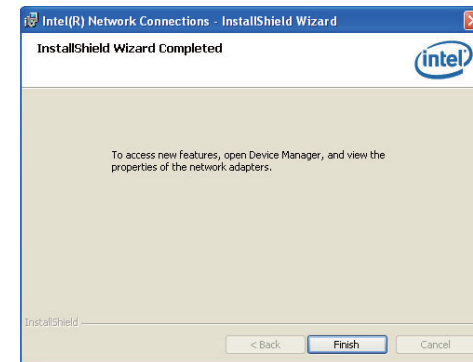

Intel Management Engine Drivers

To install the driver, click "Intel Management Engine Drivers" on the main menu.

1. Setup is ready to install the driver. Click Next.



2. Read the license agreement then click Yes.

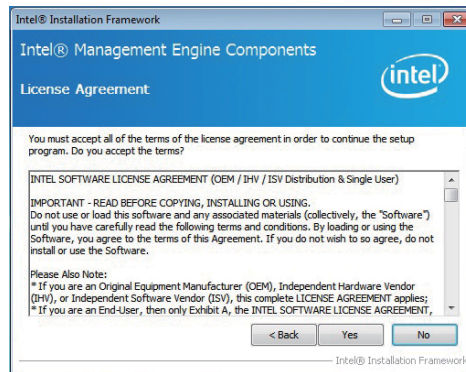

3. Setup is currently installing the driver. After installation has completed, click Next.

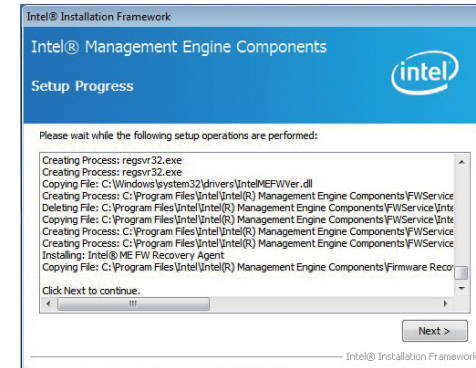

4. After completing installation, click Finish.

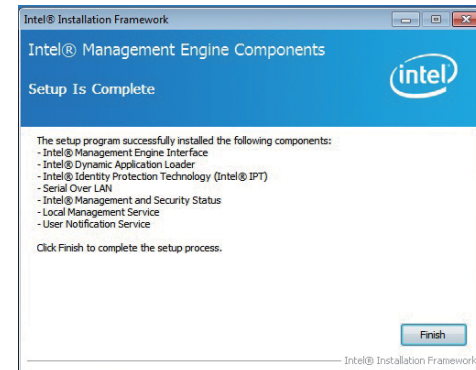

MyGuard Hardware Monitor

1. Locate for the MyGuard folder in the provided disc.
2. In the MyGuard folder, right-click on the "setup" file.
3. Select Run As Administrator.
4. Double-click Setup.

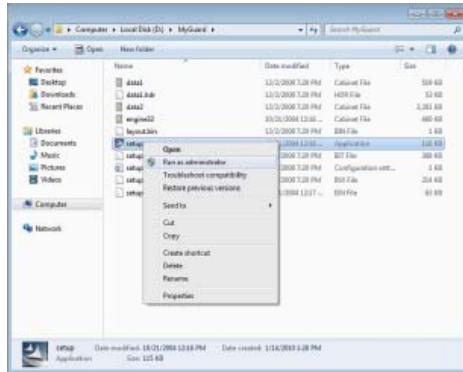

Important:

Perform steps 1-3 only when using Windows 7 or Windows Vista.

5. Setup is ready to install the utility. Click Next.

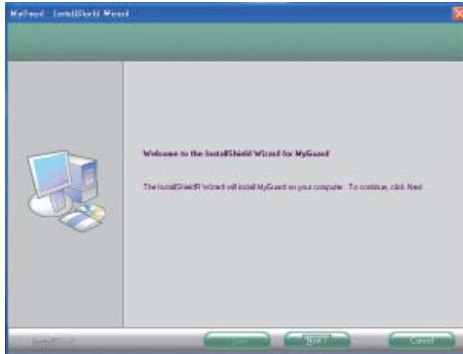

6. Click Install to begin installation.

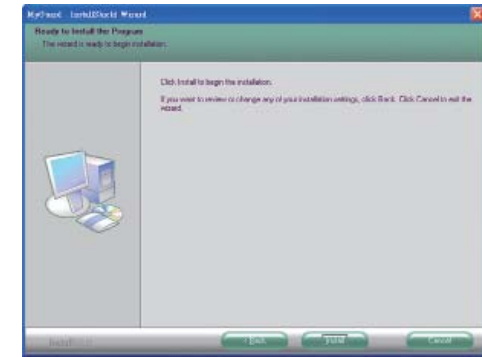

7. Setup is currently installing the utility.

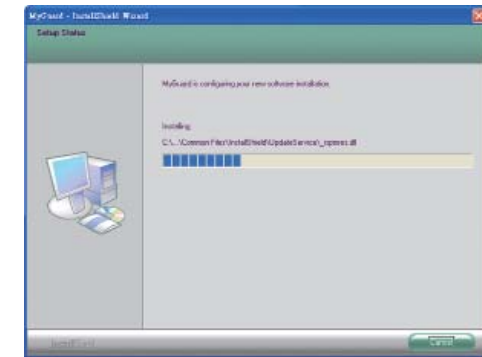

8. After completing installation, click Finish to exit setup.

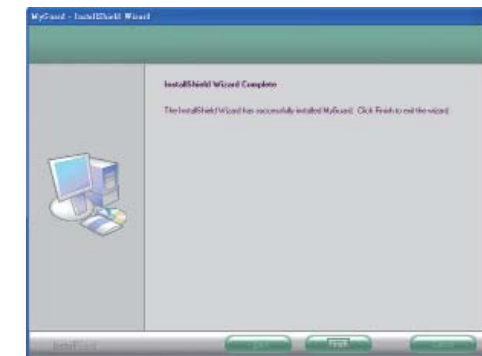

DFI Utility

DFI Utility provides information about the board, Watchdog, DIO, and Backlight. To access the utility, click "DFI Utility" on the main menu.



Note:

If you are using Windows 7, you need to access the operating system as an administrator to be able to install the utility.

1. Setup is ready to install the DFI Utility driver. Click "Next".



2. Click "I accept the terms in the license agreement" then click "Next".

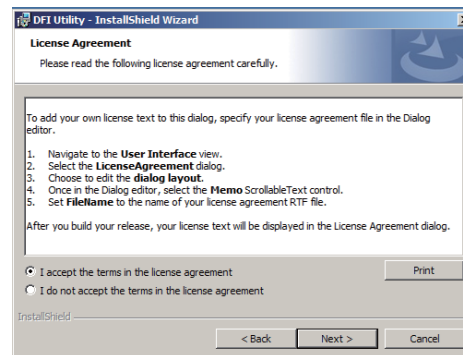

3. Enter "User name" (SB102) and "Organization" information then click "Next".

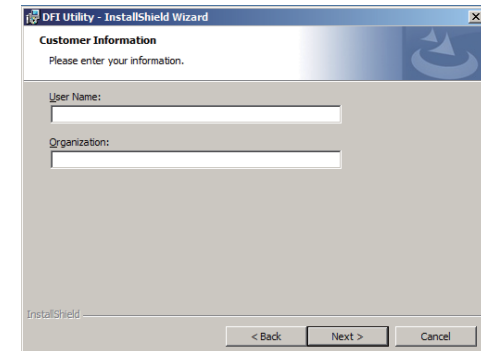

4. Click "Install" to begin the installation.

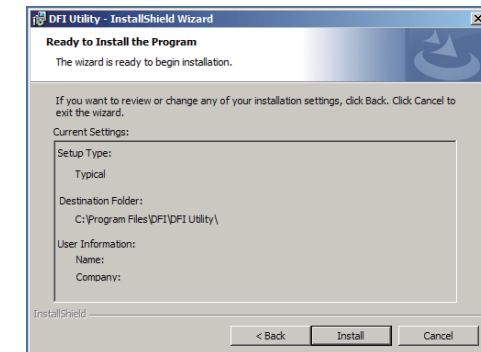

5. After completing installation, click "Finish".

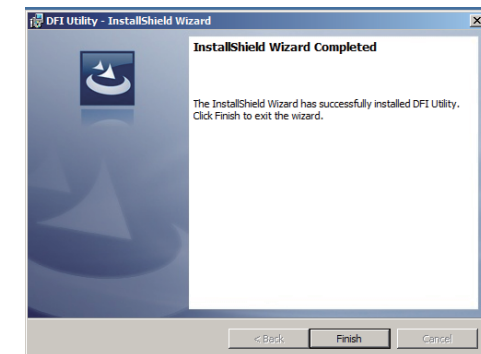

PenMount Windows Universal Driver

To install the touch screen driver, click “PenMount Windows Universal Driver” on the main menu.

1. Setup is ready to install the driver. Click “Next”.

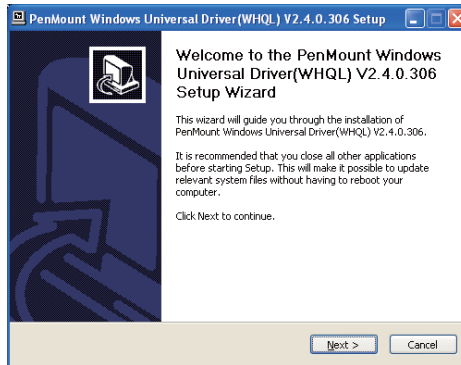

2. Click on “I agree”.

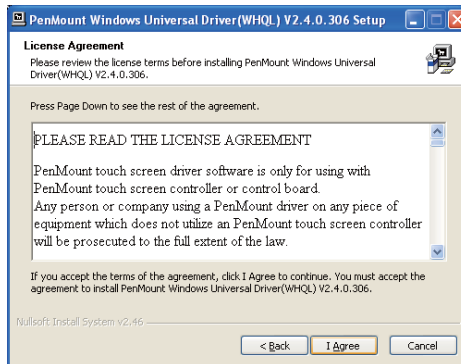

3. Click on “Browse” to install the driver in a different folder and select another folder. Click on “Install” to begin the installation.

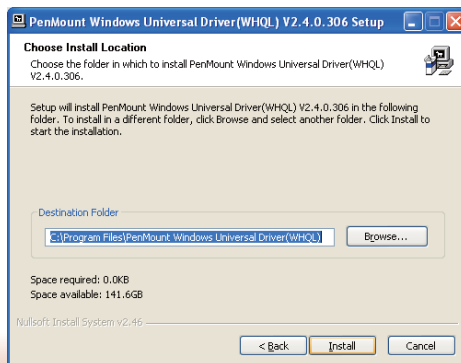

4. Setup is currently installing the utility.

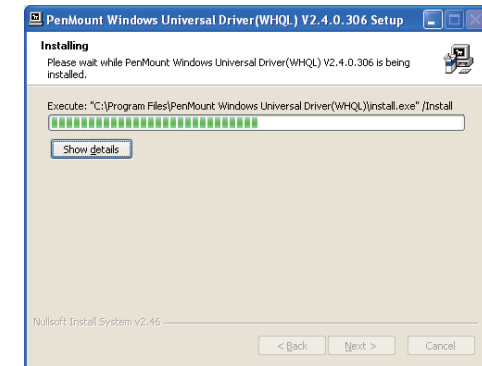

5. After completing installation, click “Finish”.

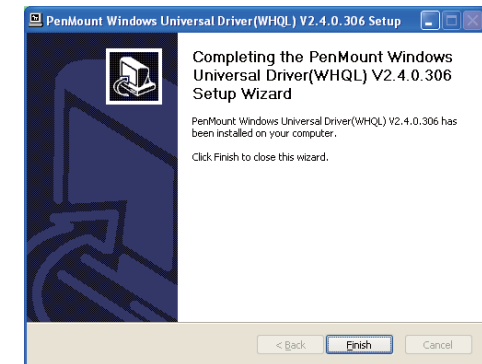

TPC121/150/170 Hotkey Driver

To install the function keys driver, click on "TPC121/150/170 Hotkey Driver" on the main menu.

1. InstallShield Wizard Setup is preparing to install, please wait.

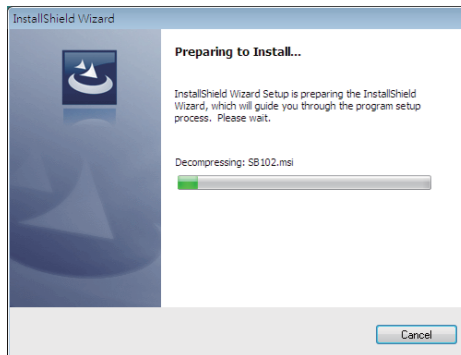

2. Setup is ready to install the driver. Click "Next".

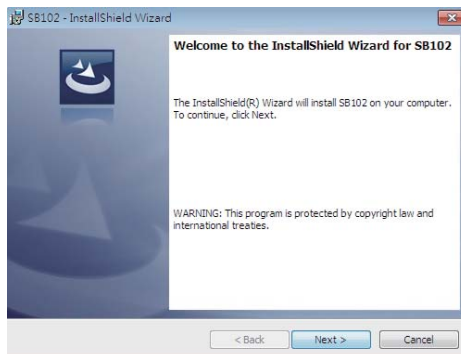

3. Click "Install" to begin the installation.

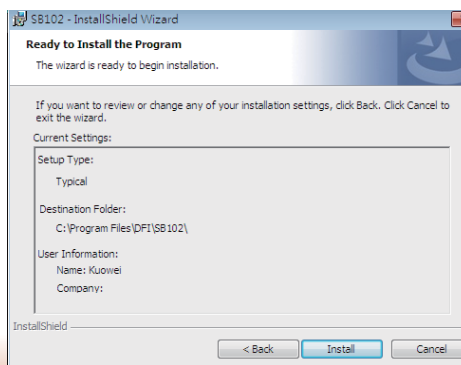

4. Setup is currently installing the utility.

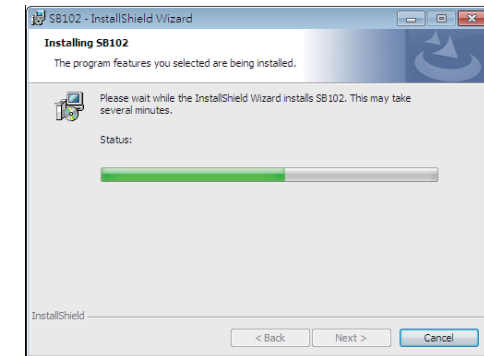

5. After completing installation, click "Finish".

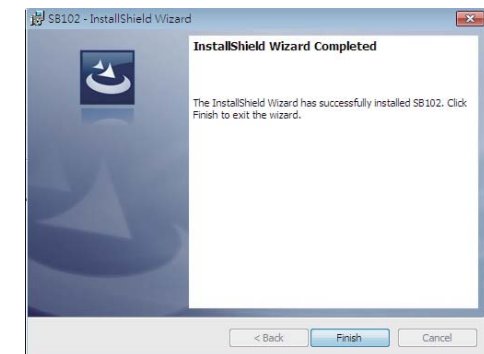

Adobe Acrobat Reader 9.3

To install the reader, click “Adobe Acrobat Reader 9.3” on the main menu.

1. Click Next to install or click Change Destination Folder to select another folder.

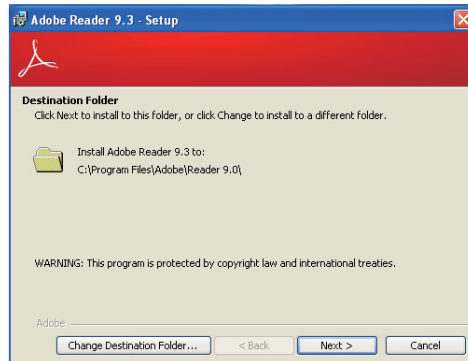

2. Click Install to begin installation.

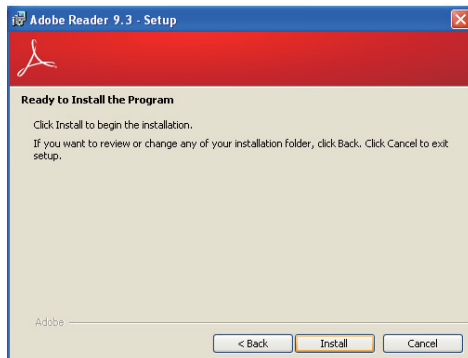

3. Click Finish to exit installation.

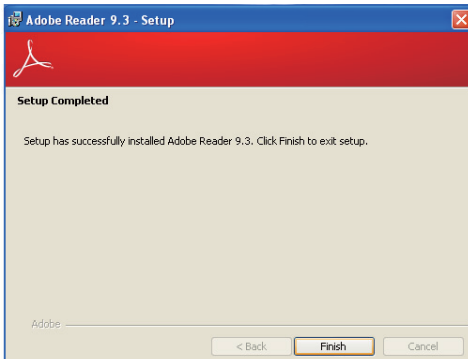

Chapter 9 - Audio Configuration

Configuring Speakers (for Windows XP only)

The following illustrations use the Windows XP operating system to configure the speaker.

1. After installing the audio driver, go to the Control Panel and double-click the "Realtek HD Sound Effect Manager" icon to open HD Audio Manager.

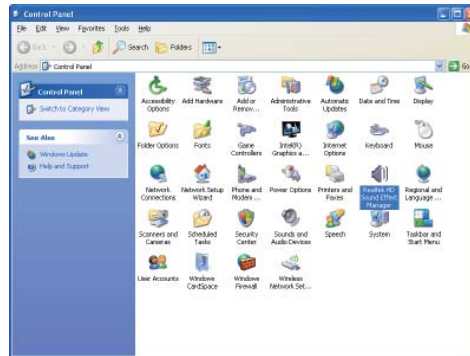

2. Click on "Audio I/O" icon to open HD Audio Manager.



3. Click on "Setting" icon.

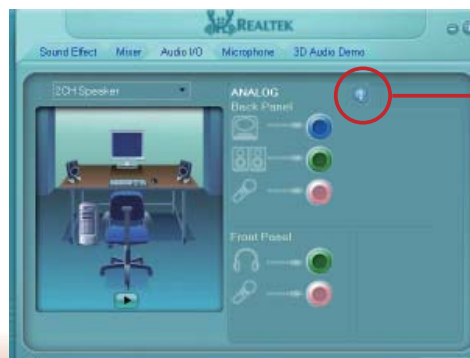

Setting icon

4. When the **Connector Settings** dialog box appears, check the "Disable front panel jack detection" box. Then click "OK".

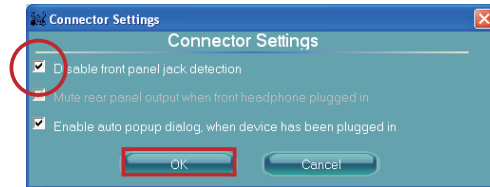

4. Click " " for testing.



Configuring Speakers (for Windows 7 only)

The following illustrations use the Windows 7 operating system to configure the speaker.

1. After installing the audio driver, go to the Control Panel and double-click the "Realtek HD Audio Manager" icon to open HD Audio Manager.

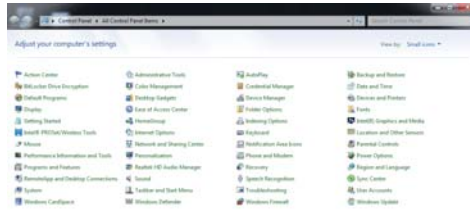

2. Click the Tool icon.



Tool icon

3. When the **Connector Settings** dialog box appears, check the "Disable front panel jack detection" box. Then click "OK".

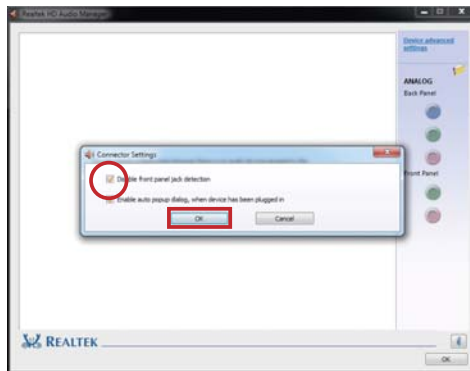

4. Click "▶" for testing.



Appendix A - Smart Fan Setting Guide

Entering the Smart Fan Function

The BIOS Setup Utility can only be operated from the keyboard and all commands are keyboard commands. The commands are available at the right side of each setup screen.

The BIOS Setup Utility does not require an operating system to run. After you power up the system, press the key or <F2>.



Note:

The BIOS is constantly updated to improve the performance of the system board; therefore the BIOS screens in this chapter may not appear the same as the actual one. These screens are for reference purpose only.

1. Select Advanced, and then PC Health Status. Enter to Smart Fan Function for the smart fan setting.

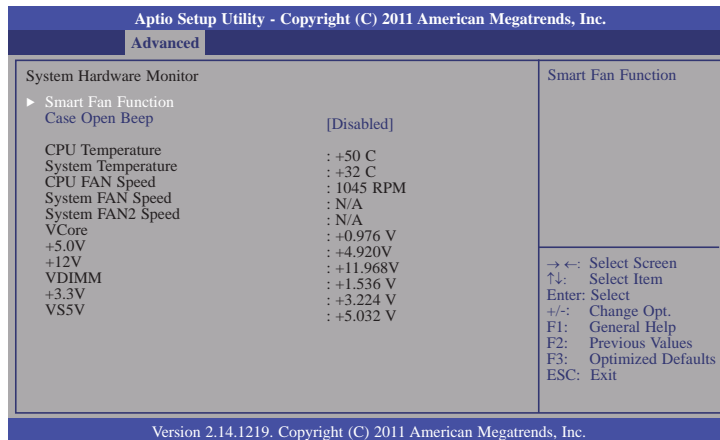

2. Smart fan has 4 boundaries and 5 Speed Count. For below configuration, Boundary 1 to Boundary 4 refers to the temperature; and Speed Count 1 to Speed Count 5 refers to the value of the speed count.

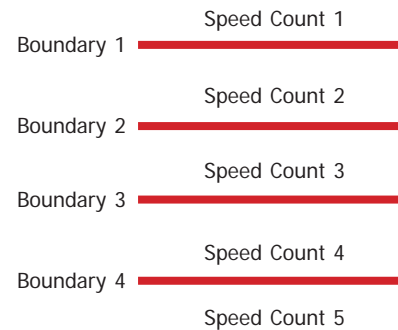
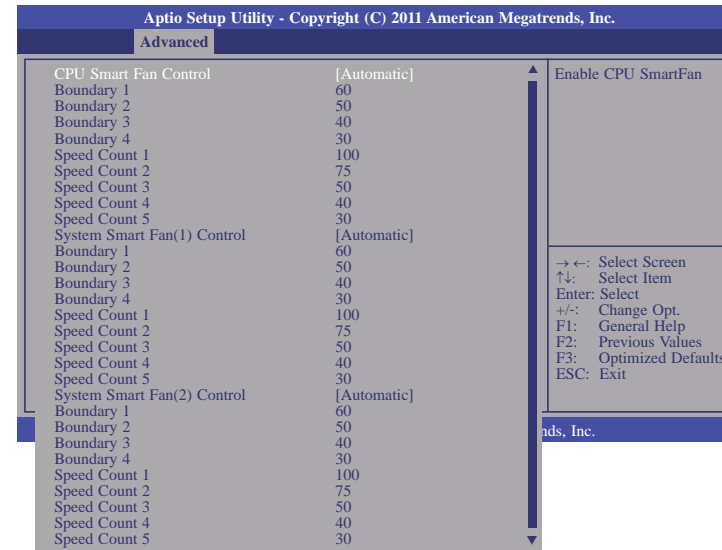

3. Speed Count and System Fan speed (rpm) matrix.

Speed Count	System Fan Speed (rpm)	Speed Count	System Fan speed (rpm)
19	3100	30	4600
20	3350	31	4650
21	3500	38	4900
22	3650	40	4950
23	3800	43	5000
24	3900	50	5050
25	4050	75	5100
26	4150	100	5150

Appendix B - Watchdog Sample Code

;Software programming example:

```

;-----
;(1) Enter Super IO Configuration mode
;-----
MOV     DX,2EH
MOV     AL,87H
OUT     DX,AL
OUT     DX,AL

;-----
;(2) Configuration Logical Device 7, register CRF5/CRF6 (WDT Control /WDT
timer)
;-----
MOV     DX,2EH
MOV     AL,07H           ;Ready to Program Logical Device
OUT     DX,AL

MOV     DX,2FH
MOV     AL,07H           ;Select Logical Device 7
OUT     DX,AL

MOV     DX,2EH
MOV     AL, F6H           ;Select watchdog timer register
OUT     DX,AL

MOV     DX,2FH
MOV     AL,10H           ;Set watchdog timer value
OUT     DX,AL

MOV     DX,2EH
MOV     AL, F5H           ;Select watchdog Control Register
OUT     DX,AL

MOV     DX,2FH
MOV     AL,61H           ;Set Watchdog Control Value
OUT     DX,AL

;-----
;(1) Exit extended function mode
;-----
MOV     DX,2EH
MOV     AL,AAH
OUT     DX,AL

```

Appendix C - System Error Message

When the BIOS encounters an error that requires the user to correct something, either a beep code will sound or a message will be displayed in a box in the middle of the screen and the message, PRESS F1 TO CONTINUE, CTRL-ALT-ESC or DEL TO ENTER SETUP, will be shown in the information box at the bottom. Enter Setup to correct the error.

Error Messages

One or more of the following messages may be displayed if the BIOS detects an error during the POST. This list indicates the error messages for all Awards BIOSes:

CMOS BATTERY HAS FAILED

The CMOS battery is no longer functional. It should be replaced.



Important:

Danger of explosion if battery incorrectly replaced. Replace only with the same or equivalent type recommended by the manufacturer. Dispose of used batteries according to the battery manufacturer's instructions.

CMOS CHECKSUM ERROR

Checksum of CMOS is incorrect. This can indicate that CMOS has become corrupt. This error may have been caused by a weak battery. Check the battery and replace if necessary.

DISPLAY SWITCH IS SET INCORRECTLY

The display switch on the motherboard can be set to either monochrome or color. This indicates the switch is set to a different setting than indicated in Setup. Determine which setting is correct, either turn off the system and change the jumper or enter Setup and change the VIDEO selection.

FLOPPY DISK(S) fail (80)

Unable to reset floppy subsystem.

FLOPPY DISK(S) fail (40)

Floppy type mismatch.

Hard Disk(s) fail (80)

HDD reset failed.

Hard Disk(s) fail (40)

HDD controller diagnostics failed.

Hard Disk(s) fail (20)

HDD initialization error.

Hard Disk(s) fail (10)

Unable to recalibrate fixed disk.

Hard Disk(s) fail (08)

Sector Verify failed.

Keyboard is locked out - Unlock the key

The BIOS detects that the keyboard is locked. Keyboard controller is pulled low.

Keyboard error or no keyboard present

Cannot initialize the keyboard. Make sure the keyboard is attached correctly and no keys are being pressed during the boot.

Manufacturing POST loop

System will repeat POST procedure infinitely while the keyboard controller is pull low. This is also used for the M/B burn in test at the factory.

BIOS ROM checksum error - System halted

The checksum of ROM address F0000H-FFFFFH is bad.

Memory test fail

The BIOS reports memory test fail if the memory has error(s).

Appendix D - Troubleshooting Checklist

Troubleshooting Checklist

This chapter of the manual is designed to help you with problems that you may encounter with your personal computer. To efficiently troubleshoot your system, treat each problem individually. This is to ensure an accurate diagnosis of the problem in case a problem has multiple causes.

Some of the most common things to check when you encounter problems while using your system are listed below.

1. The power switch of each peripheral device is turned on.
2. All cables and power cords are tightly connected.
3. The electrical outlet to which your peripheral devices are connected is working. Test the outlet by plugging in a lamp or other electrical device.
4. The monitor is turned on.
5. The display's brightness and contrast controls are adjusted properly.
6. All add-in boards in the expansion slots are seated securely.
7. Any add-in board you have installed is designed for your system and is set up correctly.

Monitor/Display

If the display screen remains dark after the system is turned on:

1. Make sure that the monitor's power switch is on.
2. Check that one end of the monitor's power cord is properly attached to the monitor and the other end is plugged into a working AC outlet. If necessary, try another outlet.
3. Check that the video input cable is properly attached to the monitor and the system's display adapter.
4. Adjust the brightness of the display by turning the monitor's brightness control knob.

The picture seems to be constantly moving.

1. The monitor has lost its vertical sync. Adjust the monitor's vertical sync.
2. Move away any objects, such as another monitor or fan, that may be creating a magnetic field around the display.
3. Make sure your video card's output frequencies are supported by this monitor.

The screen seems to be constantly wavering.

1. If the monitor is close to another monitor, the adjacent monitor may need to be turned off. Fluorescent lights adjacent to the monitor may also cause screen wavering.

Power Supply

When the computer is turned on, nothing happens.

1. Check that one end of the AC power cord is plugged into a live outlet and the other end properly plugged into the back of the system.
2. Make sure that the voltage selection switch on the back panel is set for the correct type of voltage you are using.
3. The power cord may have a "short" or "open". Inspect the cord and install a new one if necessary.

Floppy Drive

The computer cannot access the floppy drive.

1. The floppy diskette may not be formatted. Format the diskette and try again.
2. The diskette may be write-protected. Use a diskette that is not write-protected.
3. You may be writing to the wrong drive. Check the path statement to make sure you are writing to the targeted drive.
4. There is not enough space left on the diskette. Use another diskette with adequate storage space.

Hard Drive

Hard disk failure.

1. Make sure the correct drive type for the hard disk drive has been entered in the BIOS.
2. If the system is configured with two hard drives, make sure the bootable (first) hard drive is configured as Master and the second hard drive is configured as Slave. The master hard drive must have an active/bootable partition.

Excessively long formatting period.

If your hard drive takes an excessively long period of time to format, it is likely a cable connection problem. However, if your hard drive has a large capacity, it will take a longer time to format.

Serial Port

The serial device (modem, printer) doesn't output anything or is outputting garbled characters.

1. Make sure that the serial device's power is turned on and that the device is on-line.
2. Verify that the device is plugged into the correct serial port on the rear of the computer.
3. Verify that the attached serial device works by attaching it to a serial port that is working and configured correctly. If the serial device does not work, either the cable or the serial device has a problem. If the serial device works, the problem may be due to the onboard I/O or the address setting.
4. Make sure the COM settings and I/O address are configured correctly.

Keyboard

Nothing happens when a key on the keyboard was pressed.

1. Make sure the keyboard is properly connected.
2. Make sure there are no objects resting on the keyboard and that no keys are pressed during the booting process.

System Board

1. Make sure the add-in card is seated securely in the expansion slot. If the add-in card is loose, power off the system, re-install the card and power up the system.
2. Check the jumper settings to ensure that the jumpers are properly set.
3. Verify that all memory modules are seated securely into the memory sockets.
4. Make sure the memory modules are in the correct locations.
5. If the board fails to function, place the board on a flat surface and seat all socketed components. Gently press each component into the socket.
6. If you made changes to the BIOS settings, re-enter setup and load the BIOS defaults.